

# **Fluke 433/434**

Three Phase Power Quality Analyzer

## Users Manual

EN

August 2004

© 2004 Fluke Corporation, All rights reserved. Printed in the Netherlands  
All product names are trademarks of their respective companies.



# Table of Contents

Chapter	Title	Page
	<b>General Aspects .....</b>	<b>1-1</b>
	Introduction.....	1-1
	Limited Warranty & Limitation of Liability.....	1-2
	Declaration of Conformity.....	1-3
	Shipment Note .....	1-4
	Contacting a Service Center.....	1-5
	Safety Information: Read First.....	1-5
	<b>About This Manual .....</b>	<b>2-1</b>
	Introduction.....	2-1
	Users Manual Contents .....	2-1
	<b>Features Of Fluke 433/434 .....</b>	<b>3-1</b>
	Introduction.....	3-1
	General Measurements .....	3-1
	Measuring modes to investigate details .....	3-2
	<b>Basic Operations and Menu Navigation .....</b>	<b>4-1</b>
	Introduction.....	4-1
	Tilt Stand and Hang Strap.....	4-1
	Powering the Analyzer.....	4-2
	Display Brightness.....	4-3
	Locking the keyboard .....	4-3
	Menu Navigation .....	4-4
	Display Contrast .....	4-4
	Reset to Factory Defaults.....	4-4
	<b>Display Information.....</b>	<b>5-1</b>
	Introduction.....	5-1
	Phase Colors .....	5-2

Screen Types.....	5-2
Screen information common for all screen types.....	5-2
<b>Input Connections.....</b>	<b>6-1</b>
Introduction.....	6-1
Input Connections.....	6-1
<b>Scope Waveform and Phasor .....</b>	<b>7-1</b>
Introduction.....	7-1
Scope Waveform.....	7-1
Scope Phasor.....	7-2
Tips and Hints.....	7-2
<b>Volts/Amps/Hertz .....</b>	<b>8-1</b>
Introduction.....	8-1
Table .....	8-1
Trend.....	8-2
Tips and Hints.....	8-3
<b>Dips &amp; Swells.....</b>	<b>9-1</b>
Introduction.....	9-1
Trend.....	9-3
Events Tables.....	9-4
Tips and Hints.....	9-5
<b>Harmonics.....</b>	<b>10-1</b>
Introduction.....	10-1
Bar Graph Screen.....	10-1
Table .....	10-3
Trend.....	10-3
Tips and Hints.....	10-4
<b>Power &amp; Energy.....</b>	<b>11-1</b>
Introduction.....	11-1
Table .....	11-1
Trend.....	11-3
Tips and Hints.....	11-4
<b>Flicker12-1</b>	
Introduction.....	12-1
Table .....	12-1
Trend.....	12-3
Tips and Hints.....	12-4
<b>Unbalance .....</b>	<b>13-1</b>
Introduction.....	13-1
Table .....	13-1
Trend.....	13-2
Phasor .....	13-3
Tips and Hints.....	13-3

<b>Transients .....</b>	<b>14-1</b>
Introduction.....	14-1
Waveform Display .....	14-1
Tips and Hints.....	14-3
<b>Inrush Currents .....</b>	<b>15-1</b>
Introduction.....	15-1
Inrush Trend Display .....	15-1
Tips and Hints.....	15-4
<b>Power Quality Monitoring.....</b>	<b>16-1</b>
Introduction.....	16-1
Power Quality Main Screen .....	16-4
Events Table .....	16-5
Trend Display .....	16-6
Bar Graph Screen.....	16-7
<b>Cursor and Zoom .....</b>	<b>17-1</b>
Introduction.....	17-1
Cursor on Waveform Displays.....	17-1
Cursor on Trend Displays .....	17-2
From Events Table to Trend Display with Cursor On .....	17-3
Cursor on Bar graph Displays.....	17-4
<b>Setting up the Analyzer .....</b>	<b>18-1</b>
Introduction.....	18-1
General Settings.....	18-3
FUNCTION PReFerences.....	18-7
USER PReFerences.....	18-11
Limits Adjustments.....	18-13
<b>Using Memory, Printer, and PC .....</b>	<b>19-1</b>
Introduction.....	19-1
Using memory.....	19-1
Use of Printer and PC .....	19-3
<b>Tips and Maintenance.....</b>	<b>20-1</b>
Introduction.....	20-1
Cleaning the Analyzer and its Accessories .....	20-1
Storing the Analyzer .....	20-1
Keeping the Battery in Good Condition .....	20-1
Installation of Options in Fluke 433 .....	20-1
Parts and Accessories.....	20-2
Troubleshooting .....	20-3
<b>Specifications .....</b>	<b>21-1</b>
Introduction.....	21-1
Electrical Measurements.....	21-2
Trend Recording .....	21-11
Wiring Combinations.....	21-12
Display .....	21-13

Memory.....	21-13
Printers and Interface.....	21-14
Power Supply and Battery Charger.....	21-14
Mechanical.....	21-15
Environmental.....	21-15
Electro Magnetic Compatibility (EMC) .....	21-16
Safety .....	21-16

# **Chapter 1**

## **General Aspects**

### **Introduction**

This chapter informs you about a number of general and important aspects concerning the Fluke 433/434 Three Phase Power Quality Analyzer (hereafter referred to as ‘Analyzer’).

This concerns:

- Warranty and Liability Conditions.
- Declaration of Conformity.
- Shipment Note: Survey of items that should be included in your Analyzer Kit.
- Contacting a Service Center.
- Safety Information: **Read First!**

## ***Limited Warranty & Limitation of Liability***

Each Fluke product is warranted to be free from defects in material and workmanship under normal use and service. The warranty period is three years for the Analyzer and one year for its accessories. The warranty period begins on the date of shipment. Parts, product repairs and services are warranted for 90 days. This warranty extends only to the original buyer or end-user customer of a Fluke authorized reseller, and does not apply to fuses, disposable batteries or to any product which, in Fluke's opinion, has been misused, altered, neglected or damaged by accident or abnormal conditions of operation or handling. Fluke warrants that software will operate substantially in accordance with its functional specifications for 90 days and that it has been properly recorded on non-defective media. Fluke does not warrant that software will be error free or operate without interruption.

Fluke authorized resellers shall extend this warranty on new and unused products to end-user customers only but have no authority to extend a greater or different warranty on behalf of Fluke. Warranty support is available if product is purchased through a Fluke authorized sales outlet or Buyer has paid the applicable international price. Fluke reserves the right to invoice Buyer for importation costs of repair/replacement parts when product purchased in one country is submitted for repair in another country.

Fluke's warranty obligation is limited, at Fluke's option, to refund of the purchase price, free of charge repair, or replacement of a defective product which is returned to a Fluke authorized service center within the warranty period.

To obtain warranty service, contact your nearest Fluke authorized service center or send the product, with a description of the difficulty, postage and insurance prepaid (FOB Destination), to the nearest Fluke authorized service center. Fluke assumes no risk for damage in transit. Following warranty repair, the product will be returned to Buyer, transportation prepaid (FOB Destination). If Fluke determines that the failure was caused by misuse, alteration, accident or abnormal condition of operation or handling, Fluke will provide an estimate of repair costs and obtain authorization before commencing the work. Following repair, the product will be returned to the Buyer transportation prepaid and the Buyer will be billed for the repair and return transportation charges (FOB Shipping Point).

**THIS WARRANTY IS BUYER'S SOLE AND EXCLUSIVE REMEDY AND IS IN LIEU OF ALL OTHER WARRANTIES, EXPRESS OR IMPLIED, INCLUDING BUT NOT LIMITED TO ANY IMPLIED WARRANTY OF MERCHANTABILITY OR FITNESS FOR A PARTICULAR PURPOSE. FLUKE SHALL NOT BE LIABLE FOR ANY SPECIAL, INDIRECT, INCIDENTAL OR CONSEQUENTIAL DAMAGES OR LOSSES, INCLUDING LOSS OF DATA, WHETHER ARISING FROM BREACH OF WARRANTY OR BASED ON CONTRACT, TORT, RELIANCE OR ANY OTHER THEORY.**

Since some countries or states do not allow limitation of the term of an implied warranty, or exclusion or limitation of incidental or consequential damages, the limitations and exclusions of this warranty may not apply to every buyer. If any provision of this Warranty is held invalid or unenforceable by a court of competent jurisdiction, such holding will not affect the validity or enforceability of any other provision.

Fluke Corporation, P.O. Box 9090, Everett, WA 98206-9090 USA, or  
Fluke Industrial B.V., P.O. Box 90, 7600 AB, Almelo, The Netherlands



## **Declaration of Conformity**

### **Declaration of Conformity**

for

Fluke 433/434

Three Phase Power Quality Analyzers

### **Manufacturer**

Fluke Industrial B.V.

Lelyweg 1

7602 EA Almelo

The Netherlands

### **Statement of Conformity**

Based on test results using appropriate standards,  
the product is in conformity with  
Electromagnetic Compatibility Directive 89/336/EEC  
Low Voltage Directive 73/23/EEC

### **Sample tests**

Standards used:

EN 61010-1 2nd edition  
Safety Requirements for Electrical Equipment for Measurement, Control,  
and Laboratory Use

EN 61326 – 2002  
Electrical equipment for  
Measurement Control and Laboratory use  
EMC requirements

The tests have been performed in a typical configuration.

This Conformity is indicated by the symbol **CE**, i.e. “Conformité Européenne”.

## Shipment Note

The following items are included in your Analyzer Kit:

*Note:*

*When new, the Analyzer's rechargeable NiMH battery is not charged. Refer to Chapter 4 – Powering the Analyzer.*

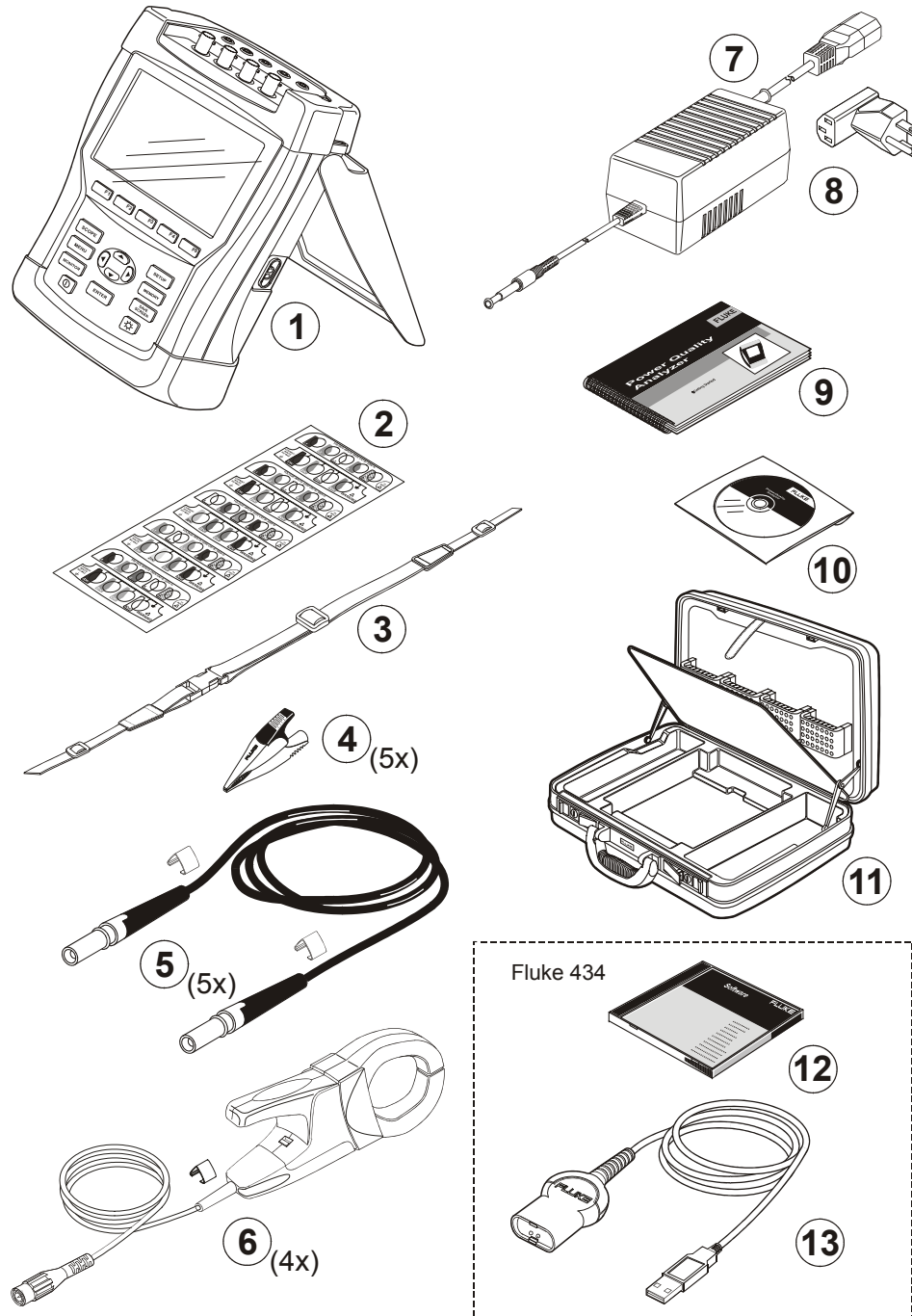

Figure 1-1. Contents of Analyzer Kit

#	Description
1	Power Quality Analyzer
2	Decal Set for Input Sockets
3	Hang Strap
4	Alligator Clips. Set of 5
5	Test Leads, 2.5 m. Set of 5
6	AC Current Clamps 400 A (1 mV/A) and 40 A (10 mV/A) switchable. Set of 4
7	Battery Charger / Power Adapter
8	Line Plug Adapter (country dependent)
9	Getting Started Manual
10	CD ROM with Users Manual and Getting Started Manual (multi-language)
11	Hard Case
12	CD ROM with FlukeView <sup>®</sup> Software for Windows <sup>®</sup> , standard for Fluke 434. Optional for Fluke 433
13	Optical Cable for USB, standard for Fluke 434. Optional for Fluke 433

## **Contacting a Service Center**

To locate a Fluke authorized service center, visit us on the World Wide Web at: [www.fluke.com](http://www.fluke.com) or call Fluke using any of the phone numbers listed below:

- +1-888-993-5853 in the U.S. and Canada
- +31-40-2675200 in Europe
- +1-425-446-5500 from other countries

## **Safety Information: Read First**

The Fluke 433/434 Three Phase Power Quality Analyzer complies with:









- ANSI/ISA S82.01-1994.
- EN/IEC61010-1 2<sup>nd</sup> edition 1000 V Measurement Category III, 600 V Measurement Cat IV, Pollution Degree 2.
- CAN/CSA-C22.2 No.61010-1-04 (including approval).

Use the Analyzer and its accessories only as specified in the *Users Manual*. Otherwise, the protection provided by the Analyzer and its accessories might be impaired.

A **Warning** identifies conditions and actions that pose hazard(s) to the user.

A **Caution** identifies conditions and actions that may damage the Analyzer.

The following international symbols are used on the Analyzer and in this manual:

	See explanation in manual		Double Insulation (Protection Class)		Disposal information
	Earth		Recycling information		
	Alternating Current		Safety Approval		
	Direct Current		Conformité Européenne		

 **Warning**

**To avoid electrical shock or fire:**

- **Review the entire manual before use of the Analyzer and its accessories.**
- **Avoid working alone.**
- **Do not operate the Analyzer around explosive gas or vapor.**
- **Use only insulated current probes, test leads and adapters as supplied with the Analyzer, or indicated as suitable for the Fluke 433/434 Analyzer.**
- **Before use, inspect the Analyzer, voltage probes, test leads and accessories for mechanical damage and replace when damaged. Look for cracks or missing plastic. Pay special attention to the insulation surrounding the connectors.**
- **Remove all probes, test leads and accessories that are not in use.**
- **Always connect the Battery Charger / Power Adapter first to the AC outlet before connecting it to the Analyzer.**
- **Use the ground input only to ground the Analyzer and do not apply any voltage.**
- **Do not apply input voltages above the rating of the instrument.**
- **Do not apply voltages in excess of the marked ratings of the voltage probes or current clamps.**
- **Do not use exposed metal BNC or banana plug connectors.**
- **Do not insert metal objects into connectors.**
- **Use only the power supply, Model BC430 (Battery Charger / Power Adapter).**
- **Before use check that the selected/indicated voltage range on the BC430 matches the local line power voltage and frequency (refer to figure below). If necessary set the slider switch of the BC430 to the correct voltage.**
- **For the BC430 use only AC line plug adapters or AC line cords that comply with local safety regulations.**

Slider switch on BC430 Battery Charger / Power Adapter to select line power voltage:



**⚠ Max. Input Voltage at Voltage Banana Inputs to Ground:**

Input A (L1), B (L2), C (L3), N to Ground: 1000 V Cat III, 600 V Cat IV.

**⚠ Max. Voltage at Current BNC Inputs (See marking):**

Input A (L1), B (L2), C (L3), N to Ground: 42 V peak.

**Voltage ratings are given as “working voltage”. They should be read as V ac rms (50-60 Hz) for AC sinewave applications and as V dc for DC applications.**

Measurement Category IV refers to the overhead or underground utility service of an installation. Cat III refers to distribution level and fixed installation circuits inside a building.

**If Safety Features are Impaired**

If the Analyzer is used in a manner not specified by the manufacturer, the protection provided by the Analyzer may be impaired.

Before use, inspect the test leads for mechanical damage and replace damaged test leads!

If the Analyzer or its accessories appear to be impaired or not functioning properly, do not use it and send it in for repair.

*Note*

*To accommodate connection to various line power sockets, the BC430 Battery Charger / Power Adapter is equipped with a male plug that must be connected to a line plug adapter appropriate for local use. Since the Charger is isolated, you can use line plug adapters with or without a protective ground terminal.*

*The 230 V rating of the BC430 is not for use in North America. A line plug adapter complying with the applicable National Requirements may be provided to alter the blade configurations for a specific country.*



# **Chapter 2**

## **About This Manual**

### **Introduction**

This Users Manual gives full and comprehensive information on how to use the Fluke 433 and 434 Three Phase Power Quality Analyzers effectively and in a safe manner. Read it carefully to learn about safe use of the Analyzer and its accessories and to take full advantage of all measuring modes.

The Analyzer is also supplied with a printed Getting Started Guide which provides basic information and can be used as a quick reference.

### **Users Manual Contents**

- Introduction: Title, Table of Contents.
- Chapter 1. General Aspects: Warranty and Liability, Declaration of Conformity, Shipment Note, Contacting a Service Center, **Safety information.**
- Chapter 2. Overview of manual contents.
- Chapter 3. Summary of measuring modes and how to use them in a logical order.
- Chapter 4. Basic operations: Tilt Stand and Hang Strap, Powering, Display adjustment, Keyboard Locking, Reset, Menu Navigation.
- Chapter 5. Display information: Screen types, General Screen Information, Screen Symbols.
- Chapter 6. Input Connections: Use of voltage and current probes.
- Chapter 7 ... 16. Explanation of measuring functions with tips & hints:
  - Scope Waveform & Phasor (7),
  - Volts/Amps/Hertz (8),
  - Dips & Swells (9),
  - Harmonics (10),
  - Power & Energy (11),
  - Flicker (12),
  - Unbalance (13),
  - Transients (14),
  - Inrush Currents (15),
  - Power Quality Monitoring (16).
- Chapter 17. Cursor and Zoom: how to investigate measurement details.

- Chapter 18. Setting up the Analyzer: a comprehensive explanation of adjustments to customize measurements.
- Chapter 19. Using Memory, printer and PC: how to save, recall and delete screenshots and data formats. How to make hard copies of measurement results and setup of communication with PC.
- Chapter 20. Tips and Maintenance: Cleaning, Storage, Batteries, Replaceable parts, Troubleshooting.
- Chapter 21. Specifications: Electrical, Mechanical, and Safety characteristics.
- Index.



# Chapter 3

## Features Of Fluke 433/434

### Introduction

The Analyzer offers an extensive and powerful set of measurements to check power distribution systems. Some give a general impression of power system performance. Others are used to investigate specific details. This chapter gives an overview on how to perform measurements in a logical order.

The measuring modes are described in detail in Chapter 7 to 16. Each measuring mode is explained in a separate chapter.

**Fluke 434 has additional features such as Interharmonics, Transients, Energy Usage, extra memory to store Screens and Data, FlukeView software, and an optical isolated interface cable. In Fluke 433 these functions can be installed optionally. If not installed, they are shown in the menus in grey color.**

### General Measurements

To check if voltage leads and current clamps are connected correctly, use Scope Waveform and Scope Phasor. The clamps are marked with an arrow to facilitate proper signal polarity. Chapter 6 Input Connections explains how to make connections.

To get a general impression of the quality of a power system use MONITOR. The MONITOR key displays a screen with Bar Graphs that show quality aspects of the phase voltages. A Bar Graph changes from green to red if the related aspect does not meet the limits. Six different sets of limits can be chosen: a number of them are user programmable. One of these sets are the limits according to the EN50160 norm. For each quality aspect submenus with detailed information are attainable via the function keys F1 ... F5.

Numerical data is shown by Volts/Amps/Hertz. For this press the MENU key. Then select Volts/Amps/Hertz and press F5 – OK to display a table with the present values of voltages (rms and peak), currents (rms and peak), frequency and Crest Factors per phase. Press F5 – TREND so display the course over time of these values.

## ***Measuring modes to investigate details***

*Phase voltages.* Should be close to the nominal value. Voltage waveforms must be a sine wave that is smooth and free from distortion. Use Scope Waveform to check the waveform shape. Use Dips & Swells to record sudden voltage changes. Use Transients mode to capture voltage anomalies.

*Phase currents.* Use Volts/Amps/Hertz and Dips & Swells to check current/voltage relations. Use Inrush Current to record sudden current increases like motor inrush.

*Crest Factor.* A CF of 1.8 or higher means high waveform distortion. Use Scope Waveform to see waveform distortion. Use Harmonics mode to identify harmonics and THD (Total Harmonic Distortion).

*Harmonics.* Use Harmonics mode to check for voltage and current harmonics and THD per phase. Use Trend to record harmonics over time.

*Flicker.* Use Flicker to check short and long term voltage flicker and related data per phase. Use Trend to record these values over time.

*Dips & Swells.* Use Dips & Swells to record sudden voltage changes as short as half a cycle.

*Frequency.* Should be close to nominal value. Frequency is normally very stable. Select Volts/Amps/Hertz to display frequency. The course of frequency over time is recorded in the Trend screen.

*Unbalance.* Each phase voltage should not differ more than 1 % from the average of the three. Current unbalance should not exceed 10 %. Use Scope Phasor or Unbalance mode to investigate unbalances.

# Chapter 4

## ***Basic Operations and Menu Navigation***

### ***Introduction***

This chapter deals with a number of general aspects of the Analyzer's operation:

- Tilt Stand and Hang Strap
- Powering the Analyzer
- Display Brightness
- Locking the keyboard
- Menu navigation
- Display Contrast
- Reset to Factory Defaults

### ***Tilt Stand and Hang Strap***

The Analyzer has a tilt stand that allows viewing the screen at an angle when placed on a flat surface. With the tilt stand folded out, the optical RS-232 port can be accessed at the right side of the Analyzer as shown in the figure.

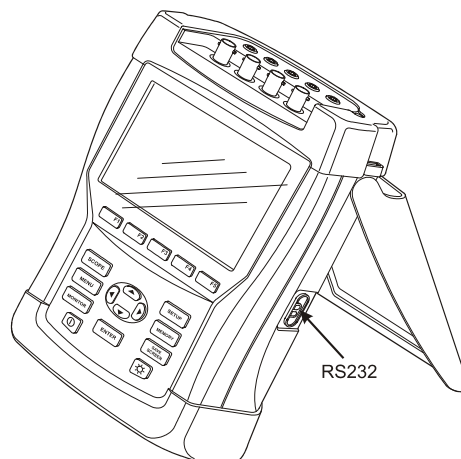

**Figure 4-1. Tilt stand and location of RS-232 interface**

A hang strap is supplied with the Analyzer. The figure below shows how to attach the strap correctly to the Analyzer.

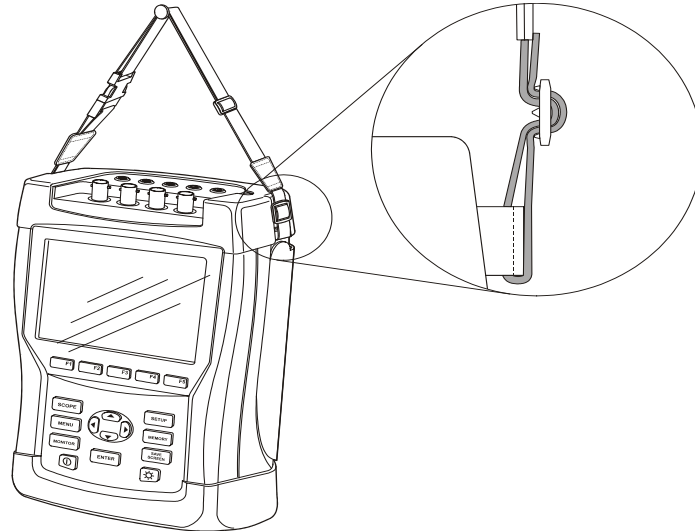

**Figure 4-2. Fixing the hang strap**

## **Powering the Analyzer**

The Analyzer has a built-in rechargeable NiMH battery that can power it for more than 6 hours when fully charged. When powered by the battery, the battery condition symbol in the screen header indicates the charge condition. This symbol ranges from fully charged to empty: ■ ■ ■ ■ □ ☒.

When empty allow the batteries to fully charge with the Battery Charger/Power Adapter model BC430. A full charge takes about 4 hours with the Analyzer turned off. When turned-on charging takes much longer.

No damage will occur if the charger is connected for long periods, e.g. over the weekend. The Analyzer automatically switches to trickle charging. At delivery the battery may be empty and it is recommended to charge it before use.

Concerning the use of the Battery Charger/Power Adapter bear the following in mind:

- Use only the supplied Battery Charger/Power Adapter model BC430.
- Before use check that the BC430 voltage and frequency match the local line power range.  
If necessary set the slider switch of BC430 to the correct voltage.
- Connect the Battery Charger to the ac outlet.
- Connect the battery charger to the POWER ADAPTER input on the top side of the Analyzer.
- To avoid overheating of the battery during charging, do not exceed the allowable ambient temperature as given in the specifications.

### Caution

**To prevent decrease of battery capacity, charge it at least twice a year.**

Power On/Off:



Press to power up or down with the last setup configuration. The welcome screen shows what Analyzer settings are currently in use. At power on a single beep can be heard.

To save battery power, the Analyzer display turns off automatically when no keys are operated during a certain time. This time is adjustable.

When a key is operated, the display turns on again.

For the adjustment of Auto-off time see Chapter 18, USER PReFereNCes.

## Display Brightness



Press repeatedly to dim/brighten the backlight. Keep pressed during 5 seconds for extra brightness for better visibility in strong sunlight. Low brightness saves battery power.

## Locking the keyboard

The keyboard can be locked to prevent unwanted operation during unattended measurements:









Press for 5 seconds to lock or unlock the keyboard.

## Menu Navigation

Most of the Analyzer functions are menu operated. Arrow keys are used to navigate through menus. The Function keys F1 ... F5 and the ENTER key are used to make selections. Active Function key selections are highlighted with a black background.

How to use the menus is illustrated in the example below on how to adjust the Analyzer for use with a certain printer type.

	The SETUP menu pops up.
	Submenu SETUP USER PREF appears.
	Highlight Printer: <b>Printer</b>
	The PRINTER submenu appears. In this menu you can adjust printer type and baudrate.
	Highlight baudrate: <b>9600</b>
	Adjust the required transmission speed.
	Highlight the Printer type you want to use: <b>Laserjet</b>
	Press to confirm the selection.
	Press to return to the next higher menu SETUP USER PREF. This menu is the starting point for many adjustments such as Display Contrast Adjustment and Reset to Factory Defaults.

## Display Contrast



Use submenu SETUP USER PREF as a starting point. How to get there is explained above under Menu Navigation:

	Adjust the Display Contrast to your personal taste.
---	---

## Reset to Factory Defaults

Proceed as follows to reset the Analyzer to factory default settings. Bear in mind that recorded data and adjustments will be lost.

Use submenu SETUP USER PREF as a starting point. How to get there is explained above under Menu Navigation:

	Press to start the reset to default settings. Because of the risk of unwanted erasure of data, a confirm menu pops up.
	Press to confirm the reset.

# Chapter 5 Display Information

## Introduction

The Analyzer uses five different screen types to present measuring results in the most effective way. The features these screens have in common are explained in this chapter. Details that are specific for a certain measuring mode are presented in the chapter explaining that mode. The figure below gives an overview of the screen types 1 .. 5; common features are explained under A ... F.

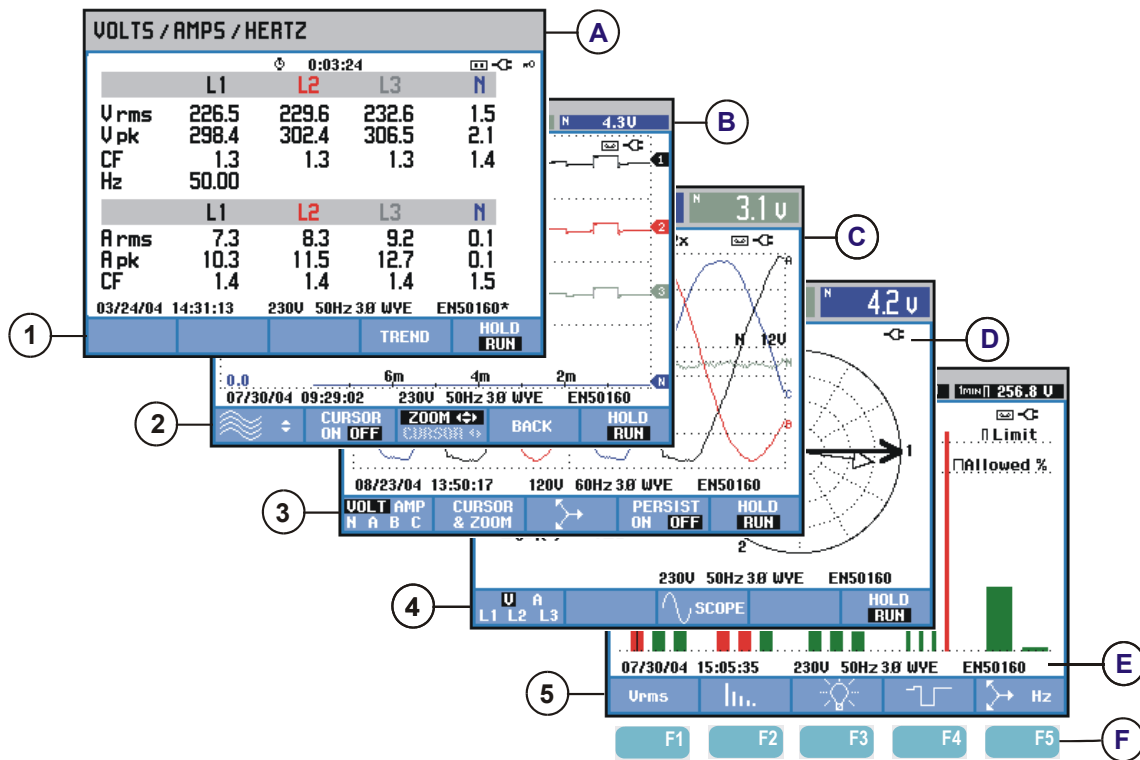

Figure 5-1. Survey of Display Types

## Phase Colors

Measuring results belonging to different phases are presented with individual colors. If for a certain phase voltage and current are displayed simultaneously, the voltage color has a dark tone and the current has a light tone. The set of phase colors can be chosen via the SETUP key and function key F4 – USER PREF. For detailed information see Chapter 18.

## Screen Types

Below you will find a brief description of each screen type and its purpose. The measuring mode it is used for is given as well as the manual chapter with detailed information. Bear in mind that the amount of screen information depends on the number of phases and the wiring configuration. Refer to Figure 5-1, item 1 ... 5.

- ① Table screen: gives an instantaneous overview of a big number of important numerical measuring values. Used for: Volts/Amps/Hertz (Chapter 8), Dips & Swells (Chapter 9), Harmonics (Chapter 10), Power & Energy (Chapter 11), Flicker (Chapter 12), Unbalance (Chapter 13), and Power Quality Monitoring (Chapter 16).
- ② Trend screen: this type of screen is related to a table screen. Trend shows the course over time of measuring values from the table. After selection of a measuring mode, the Analyzer starts recording all readings in the table. Used for: Volts/Amps/Hertz (Chapter 8), Dips & Swells (Chapter 9), Power & Energy (Chapter 11), Flicker (Chapter 12), and Inrush Currents (Chapter 15).
- ③ Waveform screen: shows voltage and current waveforms as displayed on an oscilloscope. Channel A (L1) is reference channel and 2 complete cycles starting at 0 volt are displayed. The nominal voltage and frequency determine the measuring grid size. Used for: Scope Waveform (Chapter 7) and Transients (Chapter 14).
- ④ Phasor screen: shows the phase relation between voltages and currents in a vector diagram. The vector of reference channel A (L1) points to the positive horizontal direction. The A (L1) amplitude is also reference for the measuring grid size. Used for: Scope Phasor (Chapter 7) and Unbalance (Chapter 13).
- ⑤ Bar Graph screen: shows the density of each measuring parameter as a percentage by means of a Bar Graph. Used for: Harmonics (Chapter 10) and Power Quality Monitor (Chapter 16).

## Screen information common for all screen types

Refer to Figure 5-1, item A ... F.

- Ⓐ Measuring mode: the active measuring mode is shown in the screen header.
- Ⓑ Measuring values: main numerical measuring values. Background colors differ per phase and for voltage or current. If Cursor is on, the values at the Cursor are shown.



Ⓒ Status indicators. The following symbols may appear on the screen to show the state of Analyzer and measurements:



-**9999:59:59** Time that a measurement has been going on. Format: hours, minutes, seconds. When waiting for a timed start, time counts down with prefix -.

 **2x** Horizontal ZOOM on.

**U** Measurement may be unstable. E.g. applicable for frequency readout during absence of voltage at reference phase A (L1).

**F** Indicates according to IEC61000-4-30 flagging convention that a dip, swell or interruption has occurred during the displayed aggregation interval. Indicates that an aggregated value may not be reliable.

 Recording of measurement data is on.

  Battery/Line power indication. During battery operation the battery charge condition is displayed.

 Keyboard locked. Press ENTER 5 seconds to unlock/unlock.

Ⓓ Main area with measuring data: features are explained under 1 ... 5.

Ⓔ Status line: following information appears on the screen. How to adjust these items is explained in Chapter 18 – General Settings. Following information is given:

**29/04/03** Date of Analyzer's real time clock. Date format may be month-day-year or day-month-year.

**16:45:22** Time of day or cursor time.

**230 V 50 Hz** Nominal line voltage and frequency: are a reference for the measurements.

**3Ø WYE** Number of phases and wiring configuration for the measurement.

**EN50160** Name of the limits used for the power quality MONITOR, dips, swells, interruptions, rapid voltage changes.

Ⓕ Softkey text area: softkey functions that can be selected with F1 ... F5 are indicated in white. Functions currently not available are indicated in gray. Active Function key selections are highlighted with a black background.



# **Chapter 6**

## ***Input Connections***

### ***Introduction***

This chapter explains how to make connection to the power distribution system under test and how to adjust the Analyzer settings.

Check that the Analyzer setup meets the characteristics of the system under test and the accessories that are used. This concerns:

- wiring configuration
- nominal frequency
- nominal voltage
- properties of voltage leads and current clamps

The actual setup is shown in the welcome screen that appears after power up. To change the setup, refer to Chapter 18.

### ***Input Connections***

The Analyzer has 4 BNC-inputs for current clamps and 5 banana-inputs for voltages.

Self-adhesive decals are supplied corresponding to wiring color codes used in the USA, Continental Europe, the UK, and China. Stick the decals that fit to your local wiring codes around the current and voltage inputs as shown in Figure 6-1.

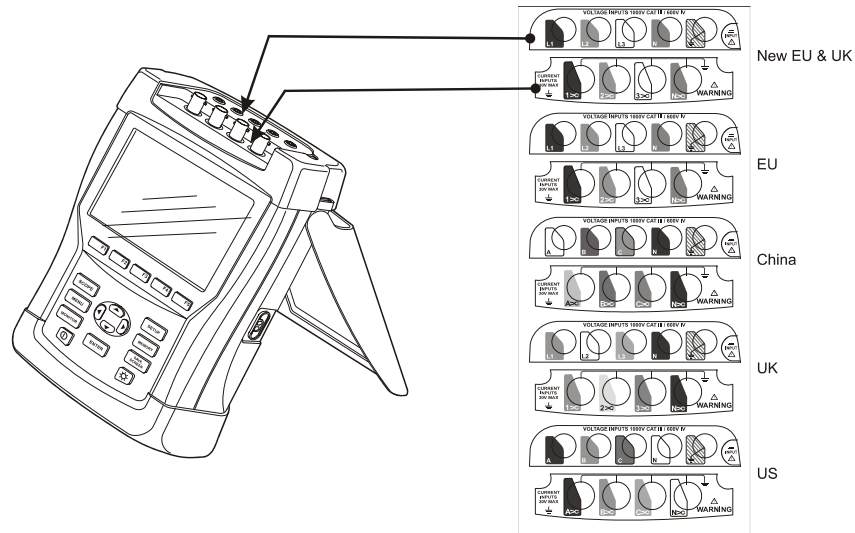

**Figure 6-1. Mounting the decals for voltage and current inputs**

De-energize power systems before making connections whenever possible. Avoid working alone and work according to the warnings listed in Chapter 1, Safety Information.

For a 3-phase system make the connections as shown in Figure 6-2.

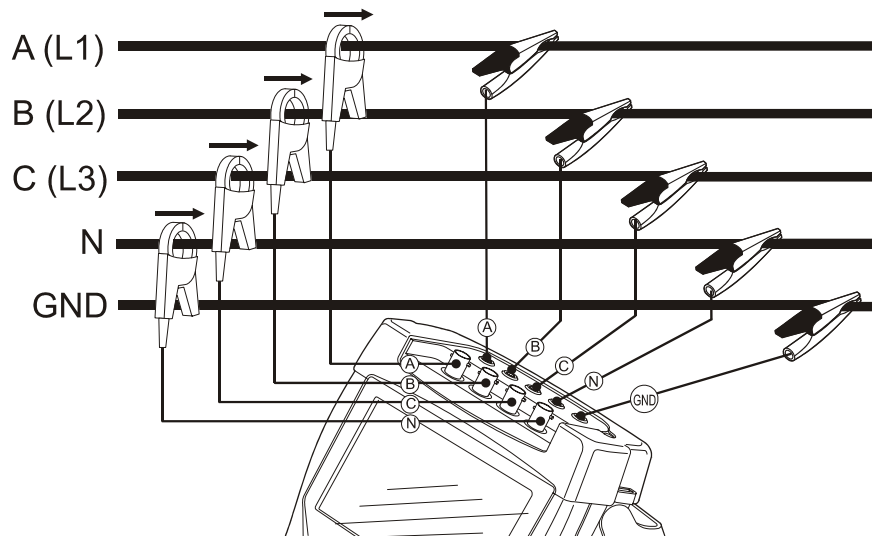

**Figure 6-2. Connection of Analyzer to 3-phase distribution system**

First put the current clamps around the conductors of phase A (L1), B (L2), C (L3), and N(utral). The clamps are marked with an arrow indicating the correct signal polarity.

Next make the voltage connections: start with Ground and then in succession N, A (L1), B (L2), and C (L3). For correct measuring results, always connect the Ground input. Always double-check the connections. Make sure that current clamps are secured and completely closed around the conductors.

For single phase measurements, use current input A (L1) and the voltage inputs Ground, N(utral), and phase A (L1).

A (L1) is the reference phase for all measurements.

Before making any measurements, set the Analyzer up for the line voltage, frequency, and wiring configuration of the power system you want to measure. This is explained in Chapter 18, General Settings.

Scope Waveform and Phasor display are useful to check if voltage leads and current clamps are connected correctly. In the vector diagram the phase voltages and currents A (L1), B (L2), and C (L3) should appear in sequence when observing them in clockwise direction as shown in the example in Figure 6-3.

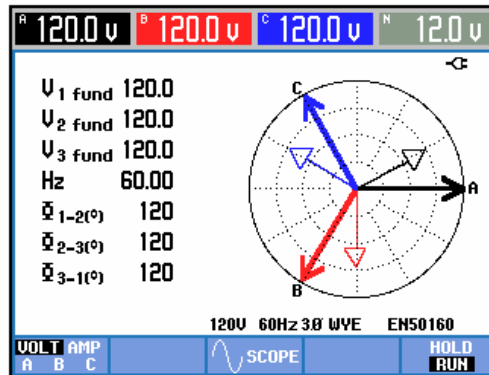

Figure 6-3. Vector diagram for correctly connected Analyzer



# Chapter 7

## Scope Waveform and Phasor

### Introduction

Scope mode shows voltages and currents in the power system under test by means of waveforms or vector diagram. Also numerical values are shown such as phase voltages, phase currents, frequency, and phase angles between voltages and currents.

### Scope Waveform

To access the Scope Waveform screen:

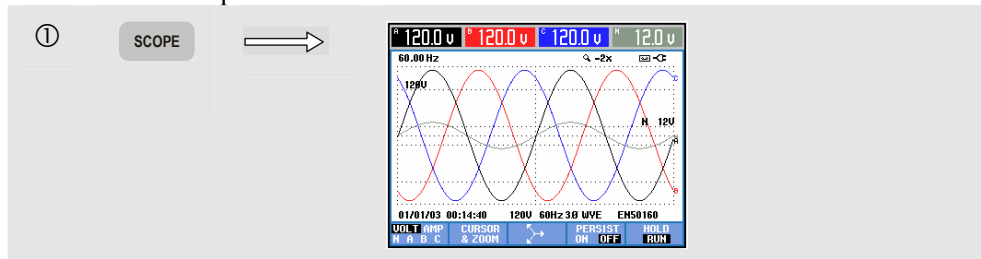

The Scope Waveform screen offers an oscilloscope style of display of voltage and/or current waveforms with a fast update rate. The screen header shows the related rms voltage/current values (12 or 10 cycle rms acc. to IEC61000-4-30). As a default 2 waveform periods are displayed. Channel A (L1) is the reference channel and 2 complete cycles starting at 0 volt are displayed.

Available function keys:

F1	Selection of waveform set to be displayed: V displays all voltages, A displays all currents. A (L1), B (L2), C (L3), N (neutral) give simultaneous display of phase voltage and current for the selected phase.
F2	Access to submenu for Cursor and Zoom operation.
F3	Access to the Phasor screen. For description see below.

F4	PERSISTENCE ON memorizes all waveform variations on screen.
F5	Switch between HOLD and RUN of screen update.

Cursor. When the Cursor is on, the waveform values at the Cursor are displayed in the screen header. Positioning the Cursor across the left or right screen end brings the next screen out of a maximum of 6 within viewing area.

Zoom. Allows you to expand or shrink the display vertically and horizontally to view details or to see the complete graph within the screen area. Zoom and Cursor are operated by the arrow keys and are explained in Chapter 17.

Offset and Span of waveforms are preadjusted for a good display in almost all cases. This is based upon Nominal Voltage (Vnom) and Current range (A Range). If desired, you can change them. The adjustment menu is reached via the SETUP key and function key F3 - FUNCTION PREF. See Chapter 18, FUNCTION PReferences.

## Scope Phasor

To access the Phasor screen:

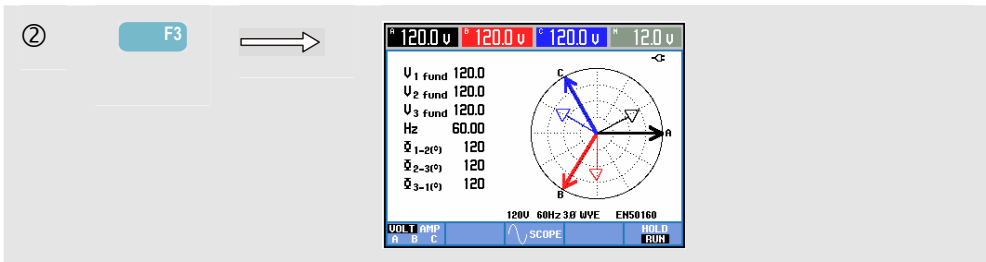

The Phasor screen displays the phase relation between voltages and currents in a vector diagram. The vector of reference channel A (L1) points in the positive horizontal direction. Additional numerical values are fundamental phase voltage, frequency, and phase angles. The screen header shows rms voltage and/or current values.

Available function keys:

F1	Selection of additional data to be displayed: all voltages, all currents, or voltage and current phase by phase.
F3	Return to the Scope Waveform.
F5	Switch between HOLD and RUN of screen update.

## Tips and Hints

Scope Waveform gives a clear view of current and voltage waveform shapes. Voltage waveforms in particular should be smooth and sinusoidal. If you see voltage distortion, it is a good idea to check the harmonics display. The rms voltages and frequency should be close to their nominal values.

Waveform and Phasor display are also useful to check if voltage leads and current clamps are connected correctly. In the vector diagram the phase voltages and currents L1 (A), L2 (B), and L3 (C) should appear in sequence when observing them in clockwise direction.



# Chapter 8

## Volts/Amps/Hertz

### Introduction

Volts/Amps/Hertz displays a table with important numerical measuring values. The related Trend screen shows the changes over time of all values in the table.

### Table

To access the VOLTS/AMPS/HERTZ Table screen:

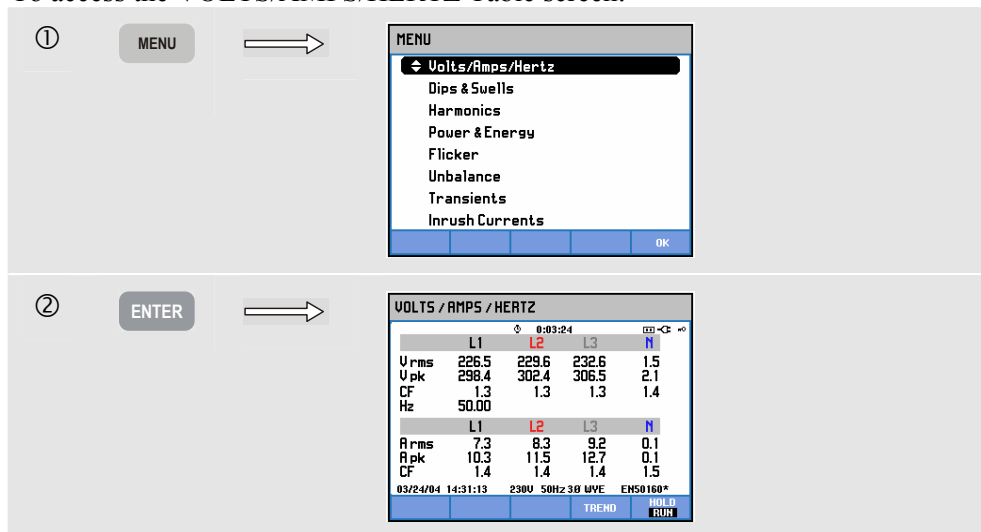

The table gives an overview of voltages and currents in all phases. Also frequency and Crest Factors are shown. The Crest Factor CF indicates the amount of distortion: a CF of 1 means no distortion and higher than 1.8 means high distortion. Use this screen to get a first impression of power system performance before examining the system in detail with other measuring modes. The number of columns in the table depends on the power system configuration.

The figures in the table are present values that may update constantly. Changes in these values over time are recorded as soon as the measurement is turned on. The recording is visible in the Trend screen.

Available function keys:

F4	Access to the Trend screen. For description see below.
F5	Switch between HOLD and RUN of screen update. Switching from HOLD to RUN invokes a menu to select immediate (NOW) or TIMED start time which allows you to define start and duration of the measurement.

## Trend

To access the VOLTS/AMPS/HERTZ Trend screen:

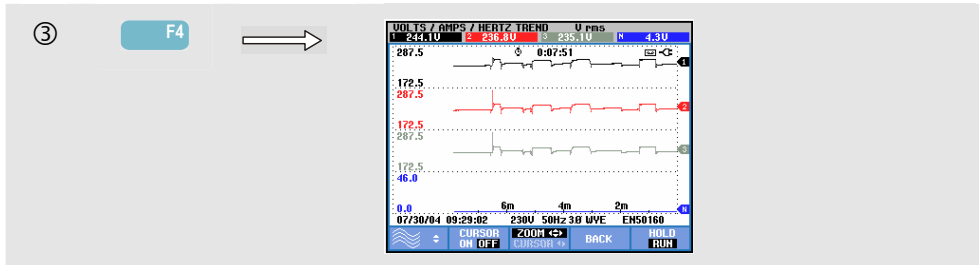

All values in the table are recorded, but the Trends from each row in the table are displayed one at a time. Press Function key F1 to assign the up/down arrow keys to row selection.

The traces build up from the right side. Readings in the header correspond to the most recent values plotted on the right.

Available function keys:

F1	Assign up/down arrow keys to select a row from the table for Trend display.
F2	Cursor on/off.
F3	Assign the arrow keys to Cursor or Zoom operation.
F4	Return to table screen.
F5	Switch between HOLD and RUN of screen update. Switching from HOLD to RUN invokes a menu to select immediate (NOW) or TIMED start time which allows you to define start and duration of the measurement.

**Cursor.** When the Cursor is on, the Trend values at the Cursor are displayed in the screen header. Moving the Cursor off the left or right side of the screen brings the next of six screens into the viewing area.

**Zoom.** Allows you to expand or shrink the display vertically or horizontally to view details or to fit a complete graph within the screen area. Zoom and Cursor are operated by the arrow keys and explained in Chapter 17.

Offset and Span of the Trends are preset for a good display in most cases, but they are adjustable. The adjustment menu is reached via the SETUP key and function key F3 - FUNCTION PREF. See Chapter 18, FUNCTION PREFERENCES.

## ***Tips and Hints***

Voltage and frequency should be close to the nominal values of for example 120 V, 230 V, 480 V, 60 Hz, or 50 Hz.

The voltages and currents in the table can e.g. be used to check if power applied to a 3-phase induction motor is in balance. Voltage unbalance causes high unbalanced currents in stator windings resulting in overheating and reduced motor life. Each of the phase voltages should not differ more than 1 % from the average of the three. Current unbalance should not exceed 10 %. In case of too high unbalance, use other measuring modes to further analyze the power system.

A Crest Factor close to 2.0 indicates high distortion.  $CF = 2.0$  can e.g. be found if you measure the current drawn by rectifiers that only conduct at the sine wave top.



# Chapter 9

## Dips & Swells

### Introduction

Dips & Swells records Dips, Interruptions, Rapid Voltage Changes, and Swells.

Dips (Sags) and Swells are fast deviations from the normal voltage. Magnitude may be ten up to hundreds of volts. Duration may vary from a half cycle to a few seconds as defined in EN61000-4-30. The Analyzer allows you to choose nominal or sliding reference voltage. A sliding reference voltage uses measured values filtered with a 1-minute time constant.

During a dip the voltage drops; during a swell the voltage rises. In three phase systems a dip begins when the voltage on one or more phases drops below the dip threshold and ends when all phases are equal to or above the dip threshold plus hysteresis. The trigger conditions for dips and swells are threshold and hysteresis. Dips and swells are characterized by duration, magnitude, and time of occurrence. Figure 9-1 and 9-2 explain this.

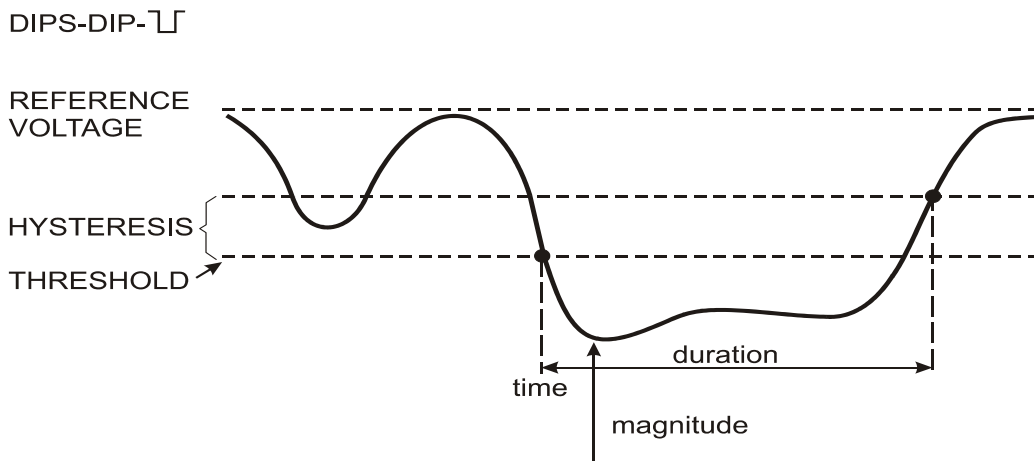

Figure 9-1. Characteristics of a voltage dip

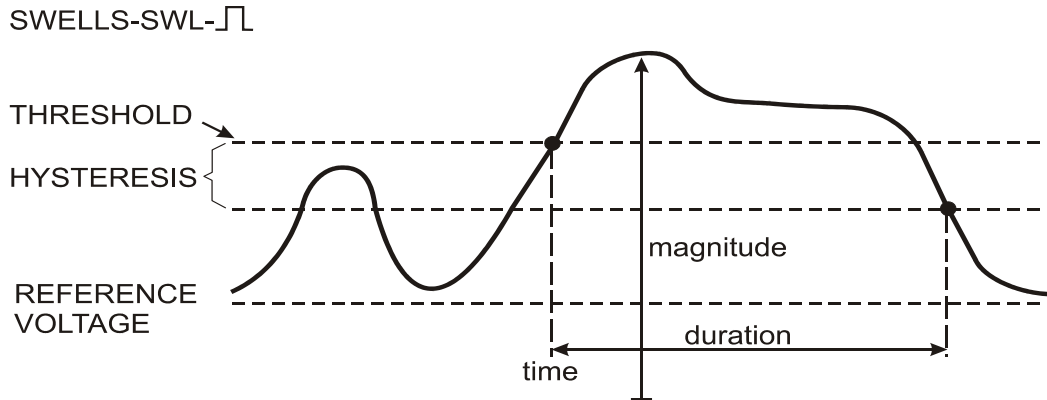

Figure 9-2. Characteristics of a voltage swell

During an Interruption the voltage sinks well below its nominal value. In three phase systems an interruption begins when the voltage on all phases are below threshold and ends when one phase is equal to or above the interruption threshold plus hysteresis. The trigger conditions for interruptions are threshold and hysteresis. Interruptions are characterized by duration, magnitude and time of occurrence. Figure 9-3 explains this.

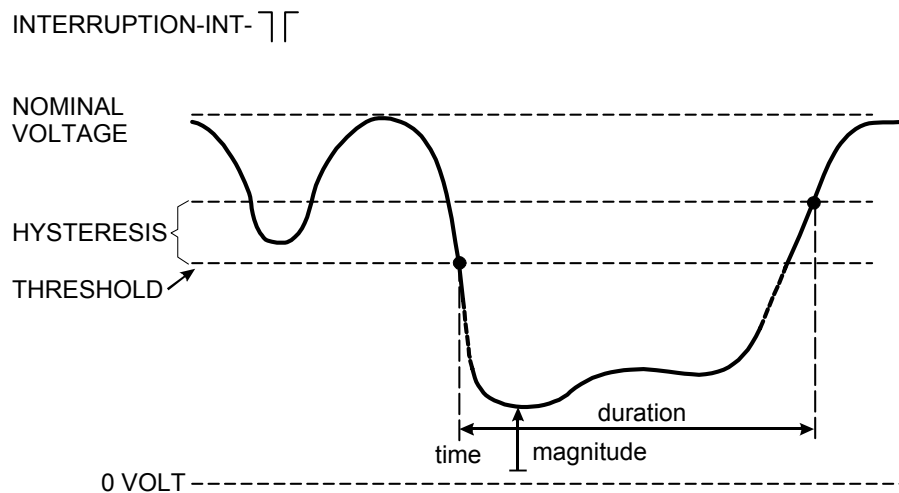

Figure 9-3. Characteristics of a voltage interruption

Rapid voltage changes are quick transitions of the RMS voltage between two steady-states. Rapid voltage changes are captured based on steady voltage tolerance, steady time, minimum step detected, and minimum rate (%/s). Figure 9-4 explains this.

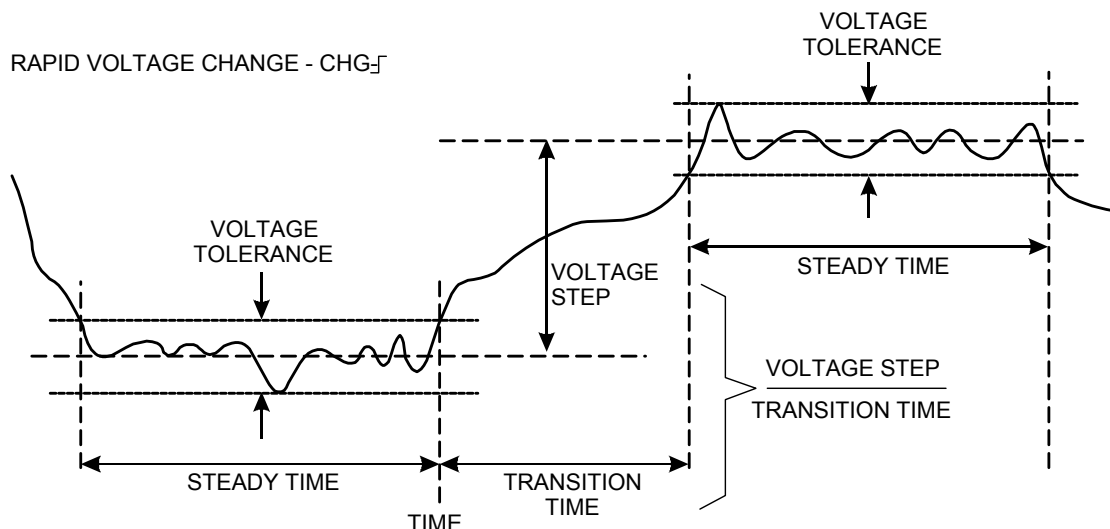
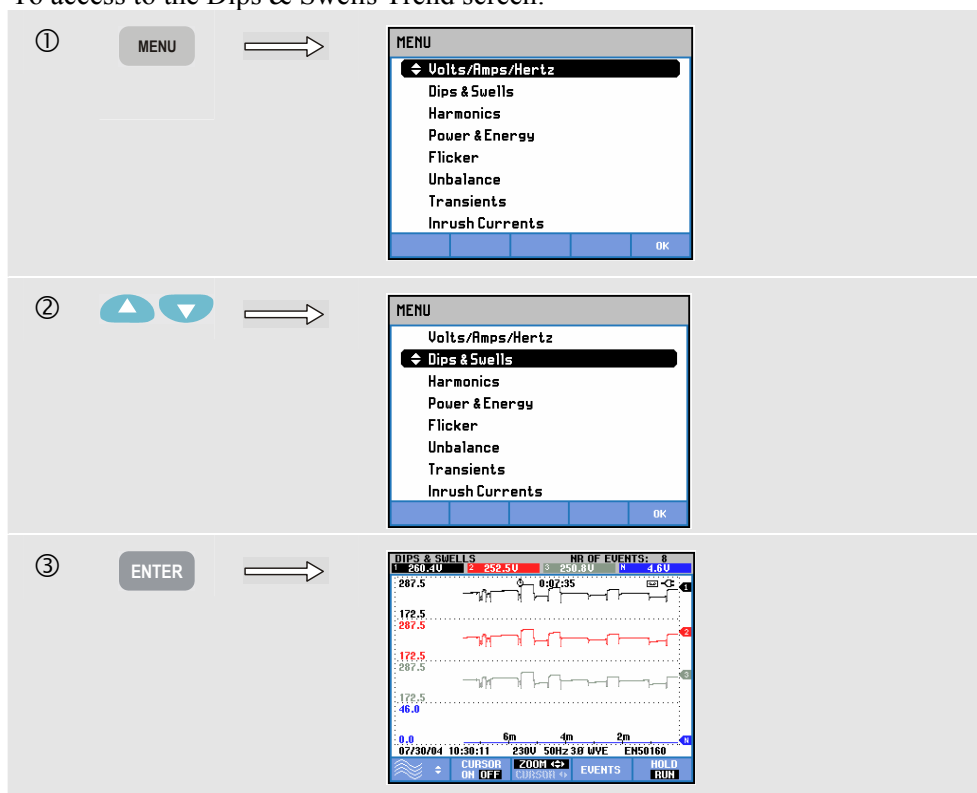

Figure 9-4. Characteristics of a rapid voltage change

In addition to the voltage, current is also recorded. This allows you to see cause and effect of deviations. Function key F4 – EVENTS accesses event tables where voltage events are listed in sequence.

## Trend

To access to the Dips & Swells Trend screen:



For the main screen all configured voltage and current channels are recorded to allow viewing of cause and effect of deviations. Not all channels are displayed simultaneously. Press function key F1 to assign the arrow keys to select the set of trends to be displayed.

The screen builds up from the right side of the screen and the corresponding values are displayed in the screen header.

Available function keys:

F1	Assign up/down arrow keys to select the voltage or current channels to be displayed.
F2	Cursor on/off.
F3	Assign the arrow keys to Cursor or Zoom operation.
F4	Access to Events tables.
F5	Switch between HOLD and RUN of screen update. Switching from HOLD to RUN invokes a menu to select immediate (NOW) or TIMED start time which allows you to define start and duration of the measurement.

**Cursor.** When the Cursor is on, the Trend values at the Cursor are displayed in the screen header. Moving the Cursor off the left or right side of the screen brings the next of six screens into the viewing area.

**Zoom.** Allows you to expand or shrink the display vertically or horizontally to view details or to fit a complete graph within the screen area. Zoom and Cursor are operated by the arrow keys and are explained in Chapter 17.

Offset and Span of the Trends are preset for a good display in most cases. This is based upon Nominal Voltage (Vnom) and Current range (A range). If desired, you can adjust Offset and Span. The adjustment menu is reached via the SETUP key and function key F3 - FUNCTION PREF. See Chapter 18, FUNCTION PReferences.

Event criteria such as threshold, hysteresis and others are preset, but they may be adjusted. The adjustment menu is reached via the SETUP key and limits setup. See Chapter 18, Limits Adjustments.

## Events Tables

To access the Dips & Swells Events Tables:

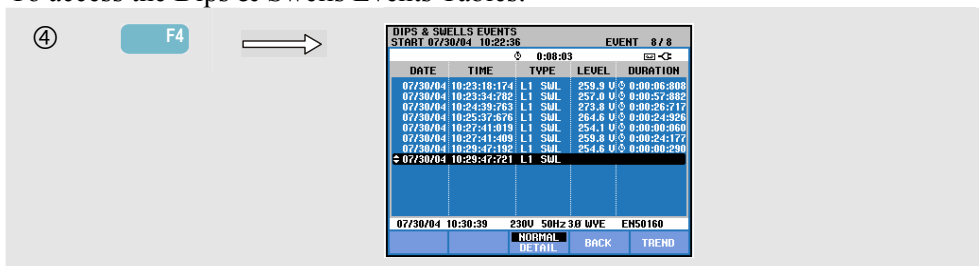



The Events table lists all threshold crossings of phase voltages. Thresholds according to international standards or user-definable thresholds can be used. Threshold adjustment is reached via the SETUP key and Limits. For detailed information see Chapter 18, Limits Adjustments.



In Normal mode major event characteristics are listed: start time, duration, and voltage magnitude. Detail shows details of threshold crossings per phase.



The following Abbreviations and Symbols are used in the tables:

Abbreviation	Description	Symbol	Description
CHG	Rapid Voltage Change	 $\uparrow$	Rising voltage edge
DIP	Voltage Dip	 $\downarrow$	Falling voltage edge
INT	Voltage Interruption		
SWL	Voltage Swell		

Available function keys:

	Switch between NORMAL and DETAILED event table.
	Return to Trend screen.
	Access Trend screen with Cursor on and positioned on the highlighted event. This event can be selected with the up/down arrow keys

## Tips and Hints

The occurrence of Dips (Sags) and Swells may indicate a weak power distribution system. In such a system voltage will change considerably when a big motor or a welding machine is switched on or off. This may cause lights to flicker or even show visible dimming. It may cause reset and loss of data in computer systems and process controllers.

By monitoring the voltage and current trend at the power service entrance, you can find out if the cause of the voltage dip is inside or outside the building. The cause is inside the building (downstream) when voltage drops while current rises; it is outside (upstream) when both voltage and current drop.



# Chapter 10

## Harmonics

### Introduction

Harmonics measures and records harmonics and interharmonics (**F1uke 434**) up to the 50<sup>th</sup>. Related data such as DC components, THD (Total Harmonic Distortion), and K-factor are measured. Harmonics are periodic distortions of voltage, current, or power sinewaves. A waveform can be considered as a combination of various sinewaves with different frequencies and magnitudes. The contribution of each of these components to the full signal is measured. Readings can be given as a percentage of the fundamental, or as a percentage of all harmonics combined. Results may be viewed in a Bar Graph display, a table, or a Trend display. Harmonics are often caused by non-linear loads such as DC power supplies in computers, TV's and adjustable speed motor drives. Harmonics can cause transformers, conductors, and motors to overheat.

### Bar Graph Screen

To access to the Harmonics Bar Graph screen:

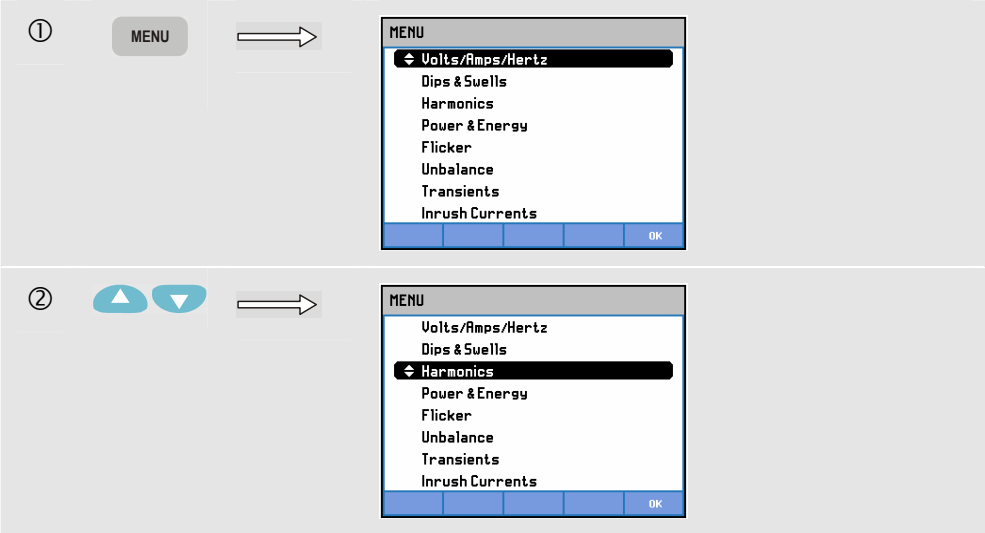

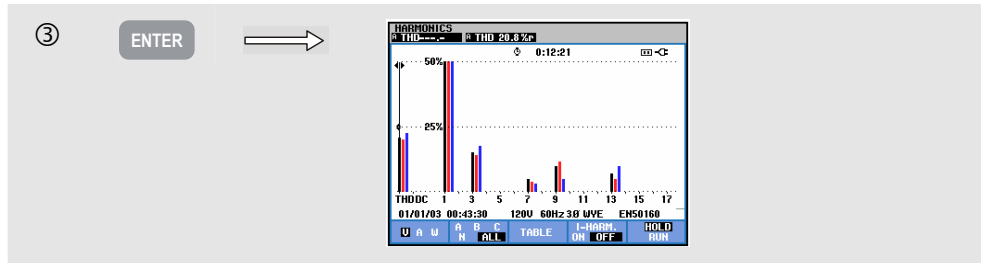

The Bar Graph display shows the percentage contribution of each of the components related to the full signal. A signal without distortion should show a 1<sup>st</sup> harmonic (= the fundamental) at 100 % while the others are at zero: in practice this will not occur because there always is a certain amount of distortion resulting in higher harmonics.

A pure sinewave becomes distorted when higher frequency components are added to it. Distortion is represented by the THD percentage. The display can also show the percentage of the DC component and the K-factor. The K-factor is a number that quantifies potential losses in transformers due to harmonic currents. Higher order harmonics influence the K-factor more than low order harmonics.

The table below shows the number of Bar Graphs displayed simultaneously in one screen:

	Harmonics	Harmonics & Interharmonics
All phase display	1 ... 12	1 ... 6
Single phase display	1 ... 50	1 ... 25

The left/right arrow keys are used to position the Cursor on a particular bar. The screen header will show for that bar phase identifier, harmonic number, frequency, and phase angle. If not all bars are shown on the screen, you can bring the next set within the viewing area by moving the Cursor off the left or right end of the screen. The up/down arrow keys are used for vertical zoom: 100 %, 50 %, 20 %, 10 %, or 5 % at full scale can be selected. Using the SETUP key and function key F3 - FUNCTION PREF you can choose harmonics display as a percentage of the fundamental voltage (%f) or the total of harmonic voltages (%r). For detailed information see Chapter 18, FUNCTION PREFERENCES.

Available function keys:

F1	Selection of harmonics type: Voltage, Current, or Real Power (Watt). Power harmonics can have positive and negative polarity.
F2	Selection of waveform set to be used: A (L1), B (L2), C (L3), N (neutral) or ALL
F3	Access the table screen.
F4	Interharmonics display on/off (Fluke 434 only).
F5	Switch between HOLD and RUN of screen update. Switching from HOLD to RUN invokes a menu to select immediate (NOW) or TIMED start time which allows you to define start and duration of the measurement.

## Table

To access the Harmonics Table screen:

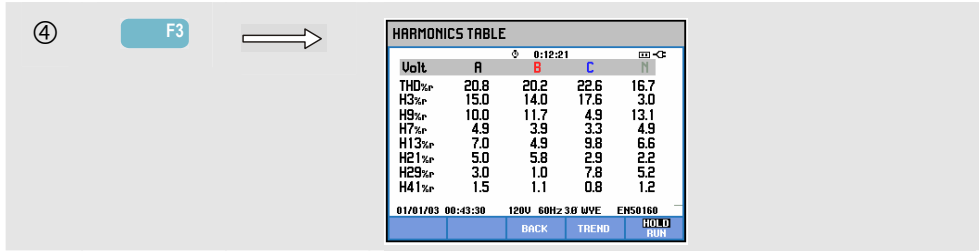

The table display shows 8 measurements per phase. Using the SETUP key and function key F3 - FUNCTION PREF you can choose the table contents. For detailed information see Chapter 18, FUNCTION PREFERenCES.

Available function keys:

F3	Return to Bar Graph screen.
F4	Access the Trend screen. For description see below.
F5	Switch between HOLD and RUN of screen update. Switching from HOLD to RUN invokes a menu to select immediate (NOW) or TIMED start time which allows you to define start and duration of the measurement.

## Trend

To access the Harmonics Trend screen:

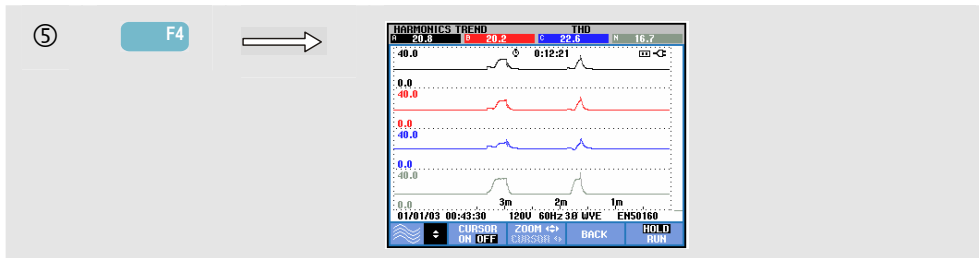

Trend shows how harmonics vary over time: Cursor and Zoom can be used to investigate details. All values in the table are recorded, but the Trends from each row in the table are displayed one at a time. Press function key F1 to assign the arrow keys to row selection.

Using the SETUP key and function key F3 - FUNCTION PREF you can choose harmonics display as a percentage of fundamental voltage (%f) or of the total of harmonic voltages (%r, total Vrms). Also the table contents can be selected in this menu. For detailed information see Chapter 18, FUNCTION PREFERenCES.

Available function keys:

F1	Assign up/down arrow keys to select a row from the table for Trend display.
F2	Cursor on/off.

F3	Assign arrow keys to Cursor or vertical Zoom operation.
F4	Return to table screen.
F5	Switch between HOLD and RUN of screen update. Switching from HOLD to RUN invokes a menu to select immediate (NOW) or TIMED start time which allows you to define start and duration of the measurement.

## Tips and Hints

The harmonic number indicates the harmonic frequency: the first harmonic is the fundamental frequency (60 or 50 Hz), the second harmonic is the component with two times the fundamental frequency (120 or 100 Hz), and so on. The harmonics sequence can be positive (+), zero (0), or negative (-). The table below gives an overview.

Order	1st	2nd	3rd	4th	5th	6th
Frequency	60 Hz 50 Hz	120 Hz 100 Hz	180 Hz 150 Hz	240 Hz 200 Hz	300 Hz 250 Hz	360 Hz 300 Hz
Sequence	+	-	0	+	-	0

Order	7th	8th	9th	10th	11th	...
Frequency	420 Hz 350 Hz	480 Hz 400 Hz	540 Hz 450 Hz	600 Hz 500 Hz	660 Hz 550 Hz	...
Sequence	+	-	0	+	-	...

Positive sequence harmonics try to make a motor run faster than the fundamental; negative sequence harmonics try to make the motor run slower than the fundamental. In both cases the motor loses torque and heats up. Harmonics can also cause transformers to overheat. Even harmonics disappear if waveforms are symmetrical, i.e. as equally positive and negative.

Zero sequence current harmonics add in Neutral conductors. This can cause overheating of these conductors.

Distortion. Current distortion is to be expected in a system with non-linear loads like DC power supplies. When the current distortion starts to cause voltage distortion (THD) of more than 5 %, this signals a potential problem.

K-factor: this is an indication of the amount of harmonic currents and can help in selecting transformers. Use the K-factor along with KVA to select a replacement transformer to handle non-linear, harmonics-rich loads.

# Chapter 11

## Power & Energy

### Introduction

Power & Energy displays a table with all important power parameters. The related Trend screen shows the changes over time of all measuring values in the table.

**Fluke 434** can also display energy usage and offers verification of energy meters with a pulse contact. For power calculations you can choose Fundamental or Full. FUNDamental considers voltage and current only at the fundamental frequency (60 or 50 Hz) for power calculations; FULL uses the full frequency spectrum (True rms voltage and current). Selection is made using the SETUP key and function key F3 - FUNCTION PREF. For detailed information see Chapter 18, FUNCTION PReferences.

### Table

To access the Power & Energy table screen:

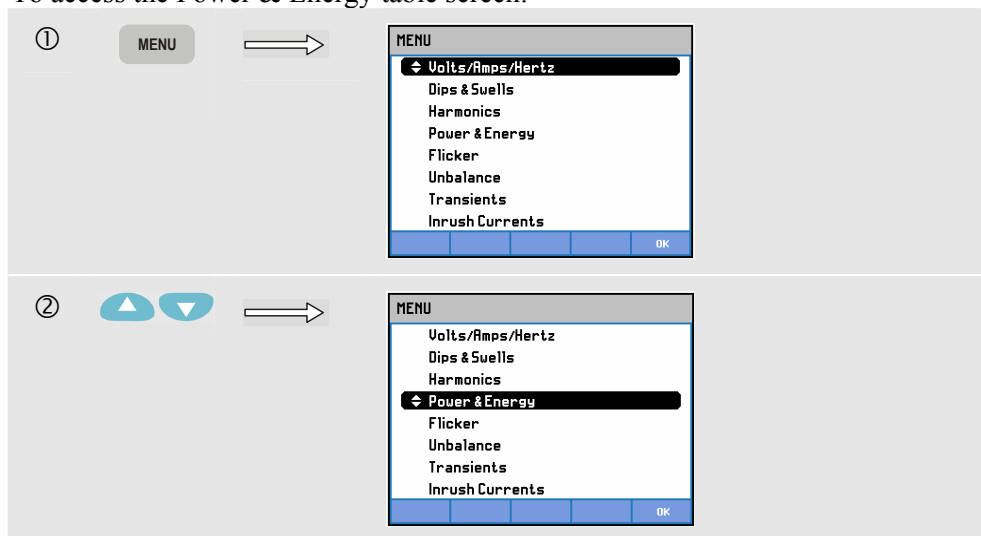

③ ENTER →

POWER & ENERGY				
	FULL		0:04:35	←-C
	L1	L2	L3	Total
kW	26.84	24.35	25.86	77.05
kVA	27.22	25.37	25.93	78.24
kVAR	± 4.56	± 7.11	± 1.90	± 13.57
PF	0.99	0.96	1.00	0.98
cosφ	0.99	0.97	1.00	
A rms	108.9	104.7	107.7	
	L1	L2	L3	
V rms	249.9	242.4	240.7	
07/30/04 11:15:50 230V 50Hz 3Φ WYE EMS0160				
ENERGY		TREND		HOLD RUN

The table displays power data for each phase and in total: real or active power (kW), apparent power (kVA, the product of rms voltage and current), reactive power (kVAR, the reactive component of apparent power caused by phase shift between AC current and voltage in inductors and capacitors), power factor (PF, the ratio of real power to apparent power for the total rms including harmonics), displacement power factor (DPF or  $\cos \phi$ , the ratio of real power to apparent power for fundamental), and the 12 or 10 cycle rms values of current and voltage.

Symbols indicate if a load is capacitive (†) or inductive (‡).

A popup table with energy usage by phase and in total can be activated on the **Fluke 434** by pressing the F3 – ENERGY softkey. The table shows real energy (kWh), apparent energy (kVAh), and reactive energy (kVARh) The energy measurement starts when Power & Energy is started. The readout can be reset with function key F5.

By using TIMED start of the measurement, the **Fluke 434** can be used to measure energy usage during a predefined period of time. TIMED start can be adjusted when switching from HOLD to RUN with function key F5. Temporarily Close ENERGY to make function key F5 available for HOLD/RUN operation.

Pulse count mode counts pulses like those available at the pulse output of certain types of energy meters. This can be used to as a quick test for revenue meter error. The pulse output is measured by means of an Optical Isolated Trigger Probe that is connected between the pulse output and the Analyzer's optical RS-232 interface. Figure 11-1 shows the measuring setup. The energy usage (kWh) per pulse must be set in advance. The adjustment menu is reached via the SETUP key and function key F3 – FUNCTION PREF. See Chapter 18, FUNCTION PREFERENCES.

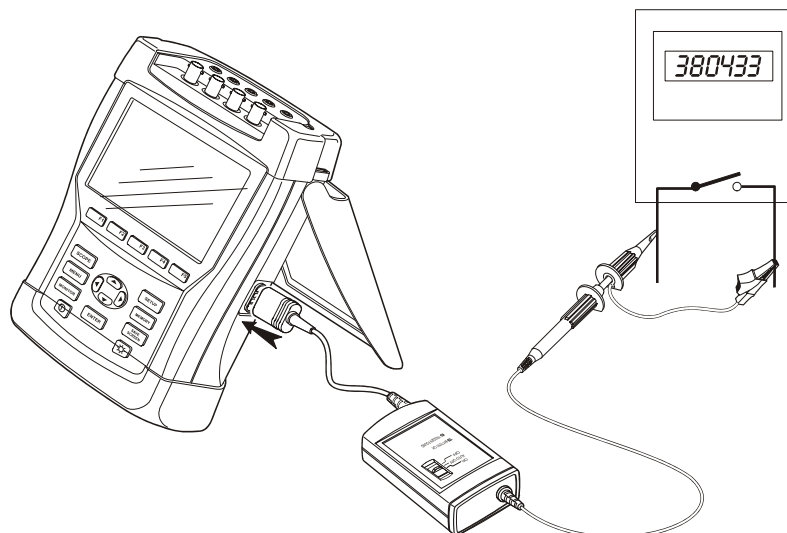
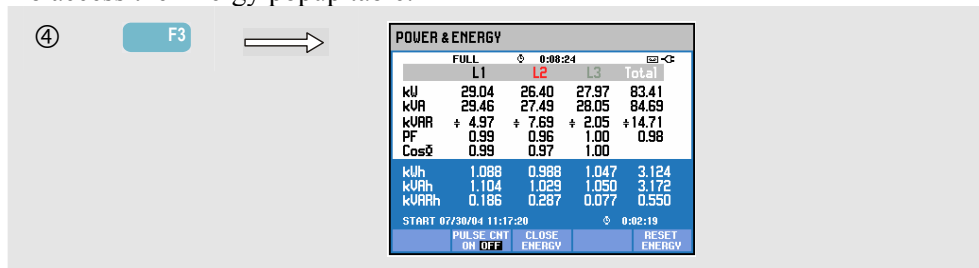

Figure 11-1. Verification of an energy meter with pulse output



To access the Energy popup table:



Available function keys:

F2	Pulse count mode on/off.
F3	Switch Energy screen on/off.
F4	Access Trend screen. For description see below.
F5	Switch between HOLD and RUN of screen update. Switching from HOLD to RUN invokes a menu to select immediate (NOW) or TIMED start time which allows you to define start and duration of the measurement. If Energy is displayed, the readout can be reset with F5.

## Trend

To access the Power & Energy Trend screen:

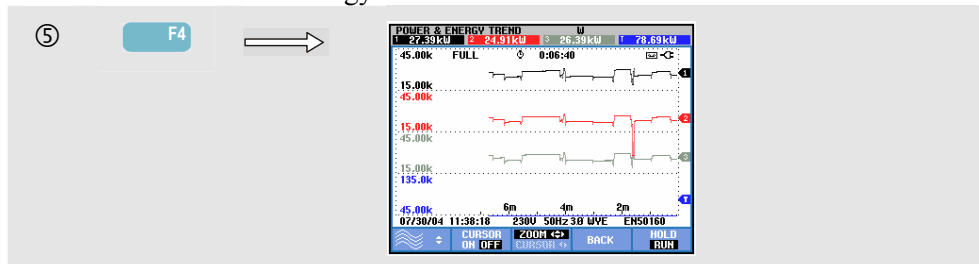

The figures in the table are instantaneous values that update constantly. Changes in these values over time are recorded whenever the measurement is active. All values in the table are recorded, but the Trends from each row in the table are displayed one at a time. Press function key F1 to assign the arrow keys to row selection.

The traces build up from the right side. The readings in the header correspond to the most recent measurements plotted on the right.

In addition to TIMED start of energy usage measurement, the Analyzer can measure average power during an adjustable time window. Electricity suppliers often bill industrial customers upon the highest average energy usage during a specified time window. For this demand interval a period of 15 minutes is common.

For any setting besides OFF horizontal scaling of the trend is fixed so that each data point corresponds with Max, Min, and Average usage during the interval. The demand interval can be adjusted between 1 ... 60 minutes or to OFF. The adjustment menu is reached via the SETUP key and function key F3 – FUNCTION PREF. See Chapter 18, FUNCTION

PREFerences. With the demand interval set to OFF the Trend functions as usual with automatic horizontal scaling.

Available function keys:

F1	Assign up/down arrow keys to select a row from the table for Trend display. The selected row is displayed in the screen header.
F2	Cursor on/off.
F3	Assign the arrow keys to Cursor or Zoom operation.
F4	Return to table screen.
F5	Switch between HOLD and RUN of screen update. Switching from HOLD to RUN invokes a menu to select immediate (NOW) or TIMED start time which allows you to define start and duration of the measurement.

Cursor. When the Cursor is on, the Trend values at the Cursor are displayed in the screen header. Moving the Cursor off the left or right side of the screen brings the next of six screens into the viewing area.

Zoom. Allows you to expand or shrink the display vertically or horizontally to view details or to fit a complete graph within the screen area. Zoom and Cursor are operated by the arrow keys and explained in Chapter 17.

Offset and Span are preset for a good display in most cases. This is based upon Nominal Voltage (Vnom) and Current range (A range). If desired, you can adjust Offset and Span. The adjustment menu is reached via the SETUP key and function key F3 - FUNCTION PREF. See Chapter 18, FUNCTION PREFerences.

## Tips and Hints

Power mode can be used to record apparent power (kVA) of a transformer over several hours. Look at the Trend and find out if there are times that the transformer is overloaded. You can transfer loads to other transformers, stagger the timing of loads, or if necessary replace the transformer with a larger one.

Interpretation of Power Factor when measured at a device:

- PF = 0 to 1: not all supplied power is consumed, a certain amount of reactive power is present. Current leads (capacitive load) or lags (inductive load).
- PF = 1: all supplied power is consumed by the device. Voltage and current are in phase.
- PF = -1: device generates power. Current and voltage are in phase.
- PF = -1 to 0: device is generating power. Current leads or lags.

If you see negative power or power factor readings and you are connected to a load, check to make sure the arrows on your current clamps are pointing towards the load.

Reactive power (VAR) is most often due to inductive loads such as motors, inductors, and transformers. Installation of correction capacitors can correct for inductive VAR's. Be sure to check with a qualified engineer before adding PF-correction capacitors, especially if you measure current harmonics in your system.

# Chapter 12

## Flicker

### Introduction

Flicker quantifies the luminance fluctuation of lamps caused by supply voltage variations. The algorithm behind the measurement meets EN61000-4-15 and is based on a perceptual model of the human eye / brain sensory system. The Analyzer converts duration and magnitude of voltage variations into an ‘annoyance factor’ caused by the resulting flicker of a 60 W lamp. A high flicker reading means that most people would find the luminance changes irritating. The voltage variation can be relatively small. The measurement is optimized to lamps powered by 120 V / 60 Hz or 230 V / 60 Hz. Flicker is characterized per phase by the parameters shown in a table. The related Trend screen shows the changes in all measuring values in the table.

#### Note

*After you have switched to Flicker, a settling time of about 10 seconds will pass before the measurement is started. During this time the U (Unstable) symbol shows in the screen header. Moreover the timer counts down from – 10 seconds. Flicker measurement has no unstable period when used with a timed start.*

### Table

To access the Flicker table screen:

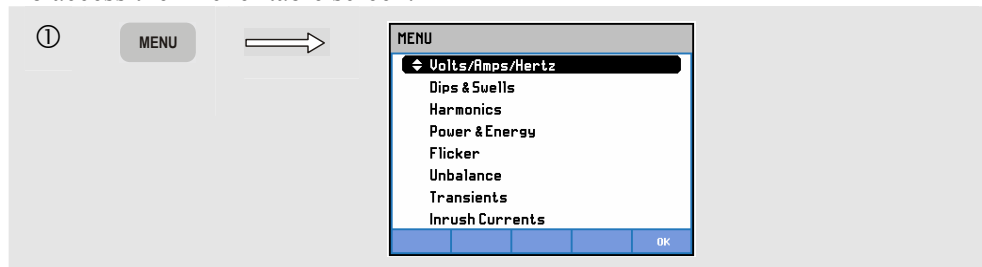

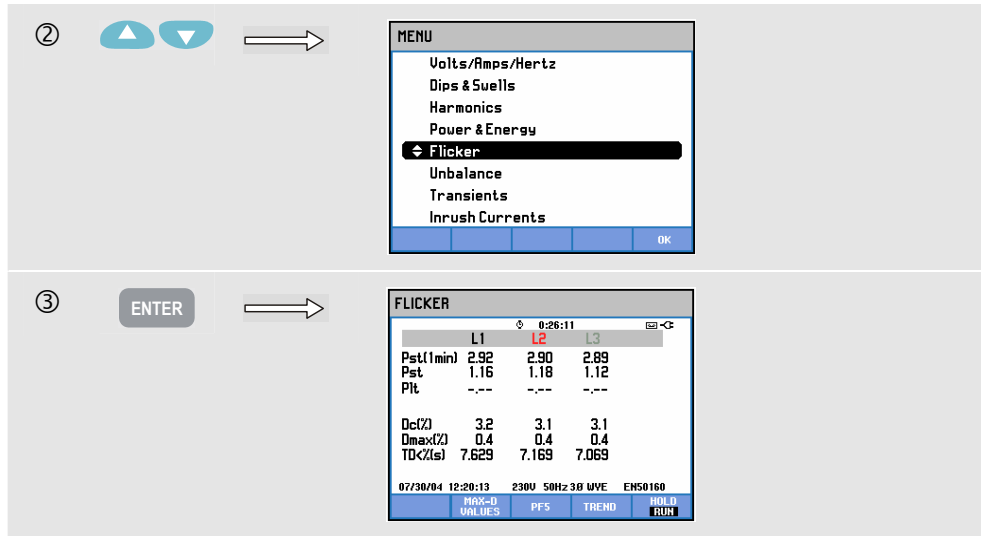

Flicker is characterized by: short term severity Pst (measured over 1 min for fast feedback), short term severity Pst (measured over 10 min) and a long term severity Plt (measured over 2 hours). This data and also the related D-parameters Dc, Dmax, and TD (acc. to EN61000-3-3) are displayed in the table.

A popup table can be switched on to show the peak values of the D-parameters that occurred during the measurement. You can reset the stored D-parameters to zero with Function key F5.

To access the popup table with peak D-parameters:

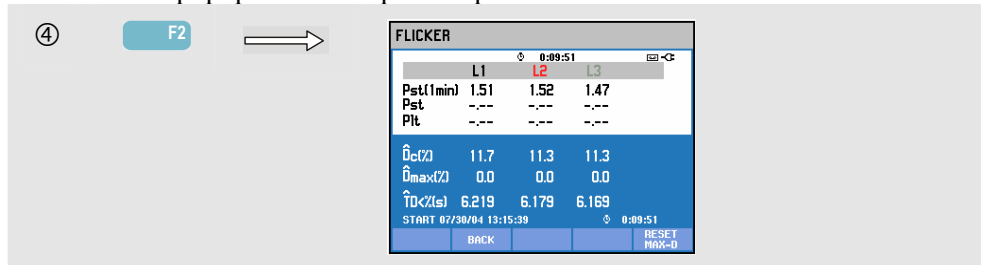

Pst and Plt are parameters showing flicker over a certain period of time. Momentary flicker is shown in the PF5 submenu and is reached via Function key F3. Flicker PF5 is displayed as a fast Trend plot.

Available function keys (popup table must be off):

F2	Activate the popup screen with maximum D-parameters.
F3	Access PF5 Trend screen.
F4	Access Trend screen. For description see below.
F5	Switch between HOLD and RUN of screen update. Switching from HOLD to RUN invokes a menu to select immediate (NOW) or TIMED start time which allows you to define start and duration of the measurement.

## Trend

To access Flicker Trend screen:

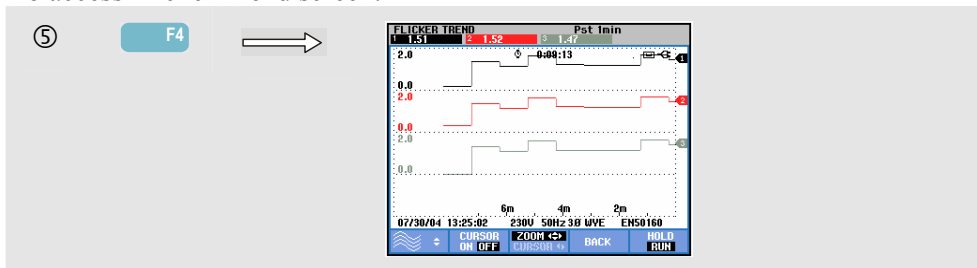

The parameters in the table update over time. They are recorded whenever the measurement is on. Trend displays the changes in these values over time. All values in the table are recorded, but the Trends from each row in the table are displayed one at a time. Press function key F1 to assign the arrow keys to row selection. The Trend display may consist of 6 screens.

PF5 displays a fast Trend plot in one screen and is reached via a menu to define expected measurement duration and Immediate or Timed measurement start. Two vertical marker lines are used to indicate a Pst period on the PF5 trend.

Available function keys:

F1	Assign up/down arrow keys to select a row from the table for Trend display. The selected row is displayed in the screen header.
F2	Cursor on/off.
F3	Assign the arrow keys to Cursor or Zoom operation.
F4	Return to table screen.
F5	Switch between HOLD and RUN of screen update. Switching from HOLD to RUN invokes a menu to select immediate (NOW) or TIMED start time which allows you to define start and duration of the measurement.

**Cursor.** When the Cursor is on, the Trend values at the Cursor are displayed in the screen header. Moving the Cursor off the left or right side of the screen brings the next of six screens (not applicable for the PF5 trend) into the viewing area.

**Zoom.** Allows you to expand or shrink the display vertically or horizontally to view details or to fit a complete graph within the screen area. Zoom and Cursor are operated by the arrow keys and explained in Chapter 17.

Offset and Span are preset for a good display in most cases, but they are adjustable. D-parameter settings are also adjustable. The adjustment menu is reached via the SETUP key and function key F3 - FUNCTION PREF. See Chapter 18, FUNCTION PREFERENCES.

## ***Tips and Hints***

Use the PF5 flicker trend and half-cycle voltage or current trends to find the source of flicker. Press function key F1 to assign the arrow keys to selection of flicker, voltage, and current trends.

The 10 min (Pst) uses a longer measuring period to eliminate the influence of random voltage variations. It is also long enough to detect interference from a single source with a long working cycle such as electrical household appliances, and heat pumps.

A measuring period of 2 hours (Plt) is useful when there may be more than one interference source with irregular working cycles and for equipment such as welding machines, and rolling mills.

# Chapter 13 Unbalance

## Introduction

Unbalance displays phase relations between voltages and currents. Measuring results are based upon the fundamental frequency component (60 or 50 Hz). In a 3-phase power system, the phase shift between voltages and between currents should be close to 120°. Unbalance mode offers a measurement table, a related Trend display, and a Phasor display.

## Table

To access the Unbalance table screen:

① MENU → MENU

- Volts/Amps/Hertz
- Dips & Swells
- Harmonics
- Power & Energy
- Flicker
- Unbalance
- Transients
- Inrush Currents

② ↑ ↓ → MENU

- Volts/Amps/Hertz
- Dips & Swells
- Harmonics
- Power & Energy
- Flicker
- Unbalance
- Transients
- Inrush Currents

③ ENTER → UNBALANCE

	Uneg.	Uzero	Aneg.	Azero
Unbal(%)	2.0	0.7	8.9	6.7
	L1	L2	L3	N
Vfund	299.6	289.8	288.6	2.2
Hz	50.01			
Afund	130.1	124.6	128.8	0.9
∅V(°)	0	-122	-240	-37
∅A-V(°)	-8	-14	-0	0

07/30/04 13:42:06 230V 50Hz 3Ø MVE ENS0160

TREND HOLD

The table screen shows all relevant numerical values: negative voltage unbalance percentage, zero sequence voltage unbalance percentage (in 4-wire systems), negative current unbalance percentage, zero sequence current unbalance percentage (in 4-wire systems), fundamental phase voltage, frequency, fundamental phase current, angle between phase-neutral voltages relative to the reference phase A/L1 and angles between voltage and current for each phase. The number of readings depends on the selected wiring configuration.

Available function keys:

F3	Access Phasor screen. For description see below.
F4	Access Trend screen. For description see below.
F5	Switch between HOLD and RUN of screen update. Switching from HOLD to RUN invokes a menu to select immediate (NOW) or TIMED start time which allows you to define start and duration of the measurement.

## Trend

To access the Unbalance trend screen:

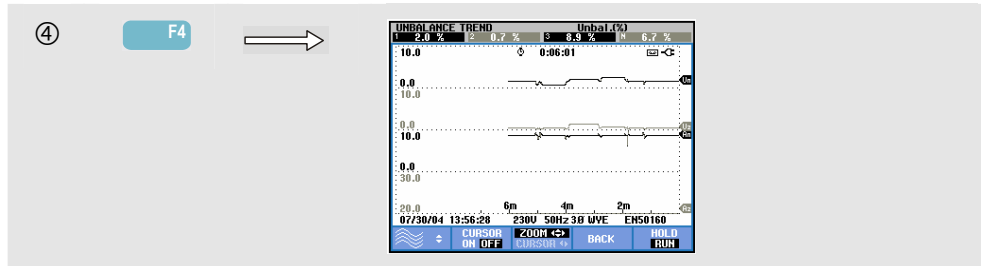

The figures in the table are instantaneous values that update constantly. Changes in these values over time are recorded whenever the measurement is active. All values in the table are recorded, but the Trends from each row in the table are displayed one at a time. Press function key F1 to assign the arrow keys to row selection. The Trend display may consist of 6 screens.

Available function keys:

F1	Assign up/down arrow keys to select a row from the table for Trend display. The selected row is displayed in the screen header.
F2	Cursor on/off.
F3	Assign the arrow keys to Cursor or Zoom operation.
F4	Return to table screen.
F5	Switch between HOLD and RUN of screen update. Switching from HOLD to RUN invokes a menu to select immediate (NOW) or TIMED start time which allows you to define start and duration of the measurement.



Cursor. When the Cursor is on, the Trend values at the Cursor are displayed in the screen header. Moving the Cursor off the left or right side of the screen brings the next of six screens into the viewing area.

Zoom. Allows you to expand or shrink the display vertically or horizontally to view details or to fit a complete graph within the screen area. Zoom and Cursor are operated by the arrow keys and explained in Chapter 17.

Offset and Span are preset for a good display in most cases, but they are adjustable. The adjustment menu is reached via the SETUP key and function key F3 - FUNCTION PREF. See Chapter 18, FUNCTION PReferences.

## Phasor

To access the Unbalance Phasor screen:

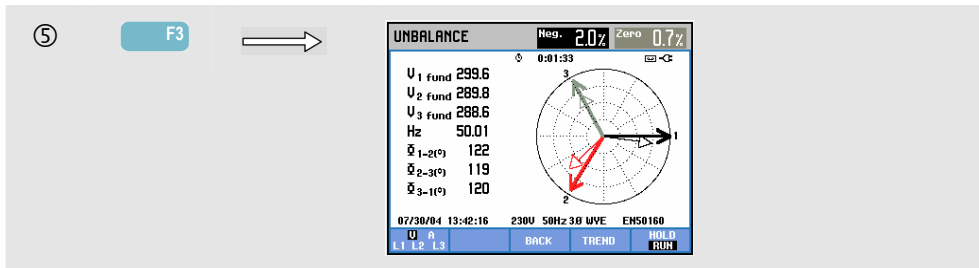

Shows the phase relation between voltages and currents in a vector diagram divided in 30 degree sections. The vector of the reference channel A (L1) points to the positive horizontal direction. A similar vector diagram is displayed under Scope Phasor. Additional numerical values are given: negative voltage or current unbalance percentage, zero sequence voltage or current unbalance percentage, fundamental phase voltage or current, frequency, phase angles. With function key F1 you can choose readings of all phase voltages, all phase currents, or voltage and current in one phase.

Available function keys:

F1	Selection of signals to be displayed: V displays all voltages, A displays all currents. A (L1), B (L2), C (L3), N (neutral) give simultaneous display of phase voltage and current.
F3	Return to table screen.
F4	Access to trend screen.
F5	Switch between HOLD and RUN of screen update. Switching from HOLD to RUN invokes a menu to select immediate (NOW) or TIMED start time which allows you to define start and duration of the measurement.

## Tips and Hints

The voltages and currents in the table can e.g. be used to check if power applied to a 3-phase induction motor is in balance. Voltage unbalance causes high unbalanced currents in stator windings resulting in overheating and reduced motor life. Each of the phase voltages should not differ more than 1 % from the average of the three. Current

unbalance should not exceed 10 %. In case of too high unbalance, use other measuring modes to further analyze the power system.

Each phase voltage or current can be split-up into three components: positive sequence, negative sequence, and zero sequence.

The positive sequence component is the normal component such as present in balanced 3-phase systems. The negative sequence component results from unbalanced phase-to-phase currents and voltages. This component for instance causes a 'braking' effect in 3-phase motors: this will result in overheating and life reduction.

Zero sequence components may appear in an unbalanced load in 4 wire power systems and represent the current in the N (Neutral) wire. Unbalance exceeding 2 % is considered as too high.

# Chapter 14 Transients

## Introduction

The **Fluke 434** Analyzer can capture waveforms at high-resolution during a variety of disturbances. The Analyzer will give a snapshot of the voltage and current waveforms at the precise time of the disturbance. This allows you to see the waveforms during dips, swells, interruptions, current swells and transients.

Transients are fast spikes on the voltage (or current) waveform. Transients can have so much energy that sensitive electronic equipment can be affected or even damaged. The Transients screen looks similar to that of Scope Waveform, but its vertical span is enlarged to make voltage spikes visible that are superimposed on the 60 or 50 Hz sinewave. A waveform is captured each time that the voltage (or rms current) exceeds adjustable limits. A maximum of 40 events can be captured. The sample rate is 200 kS/s.

## Waveform Display

To access the Transients Waveform screen:

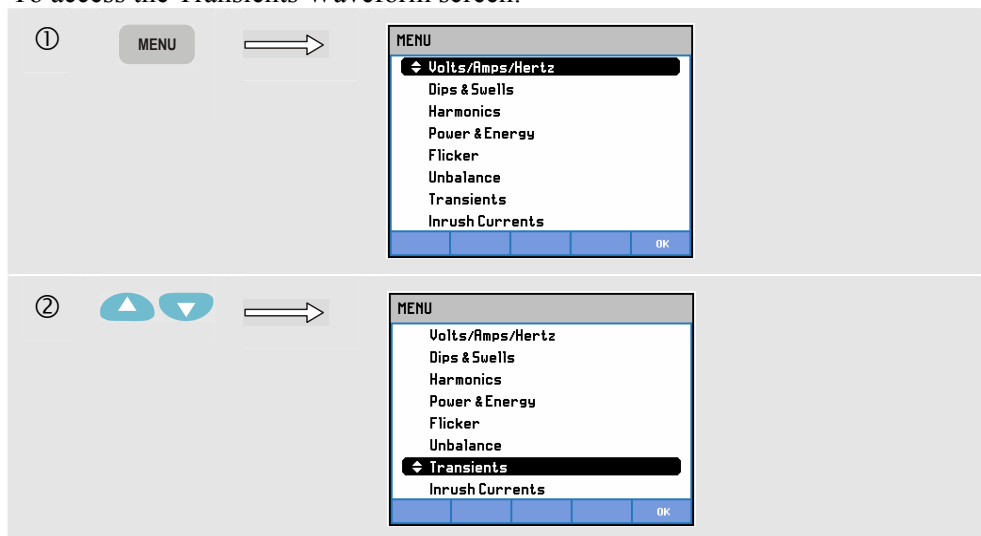

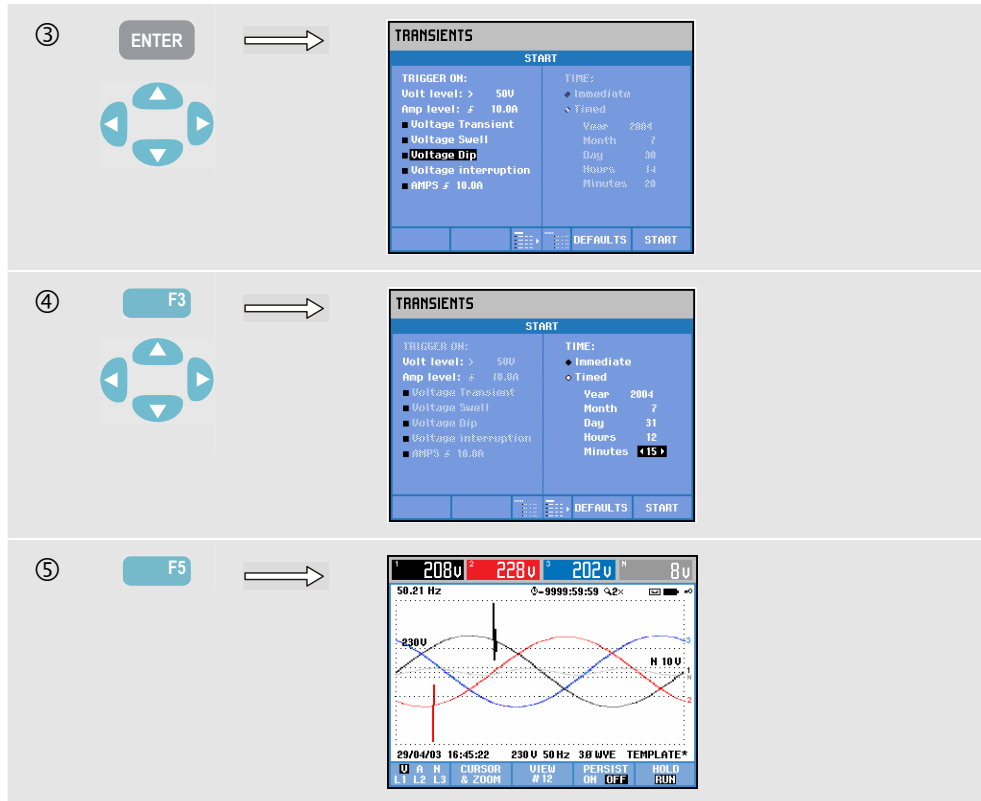

In the Start menu you can choose a trigger event or a combination of trigger events, transients (Volt) and current (AMP) trigger level, and Immediate or Timed start of the measurement.

The Analyzer may be set up to capture waveforms each time it sees: Voltage Transient, Voltage Swell, Voltage Dip, Voltage Interruption, or Current swell. Dips (sags) and swells are fast deviations from the nominal voltage. Duration is between one cycle to a few seconds. During a dip the voltage sinks, and during a swell the voltage rises. During an interruption the voltage falls to only a few percent of its nominal value. A current swell is a current increase from one cycle to several seconds in duration.

Trigger criteria such as threshold and hysteresis are adjustable. These criteria are also used for Power Quality Monitor: Adjustment is reached via the SETUP key, 'limits' selection, and then Function key F3 - EDIT. How to proceed is explained in Chapter 18 Setup.

Cursor and Zoom can be used to investigate details of captured waveforms. Via the SETUP key and function key F3 - FUNCTION PREFERENCE you can adjust the limits associated with each type of trigger event. For detailed information see Chapter 18, FUNCTION PREFERENCES.

Available function keys:

F1	Selection of waveform set to be displayed: V displays all voltages, A displays all currents. A (L1), B (L2), C (L3), N (neutral) give simultaneous display of phase voltage and current.
F2	Access submenu for Cursor and Zoom operation.

F3	Assign up/down arrow keys to browse through all captured screens.
F4	Persistence on memorizes all waveform variations.
F5	Switch between HOLD and RUN of screen update. Switching from HOLD to RUN invokes a menu to select immediate (NOW) or TIMED start time which allows you to define start and duration of the measurement.

### ***Tips and Hints***

Disturbances such as transients in a power distribution system can cause malfunctions in many types of equipment. For example, computers may reset and equipment subjected to repeated transients can eventually fail. Events occur intermittently, making it necessary to monitor the system for a period of time to find them. Look for voltage transients when electronic power supplies are failing repeatedly or if computers reset spontaneously.



# Chapter 15

## Inrush Currents

### Introduction

Inrush Currents can be captured by **Fluke 434**. Inrush Currents are surge currents that occur when a large, or low-impedance load comes on line. Normally the current will stabilize after some time when the load has reached normal working condition. For example the start-up current in induction motors can be ten times the normal working current. Inrush is a ‘single shot’ mode that records current and voltage Trends after a current event (the trigger) has occurred. An event occurs when the current waveform exceeds adjustable limits. The display builds up from the right of the screen. Pretrigger information allows you to see what occurred in advance of the inrush.

### Inrush Trend Display

To access the Inrush Trend screen:

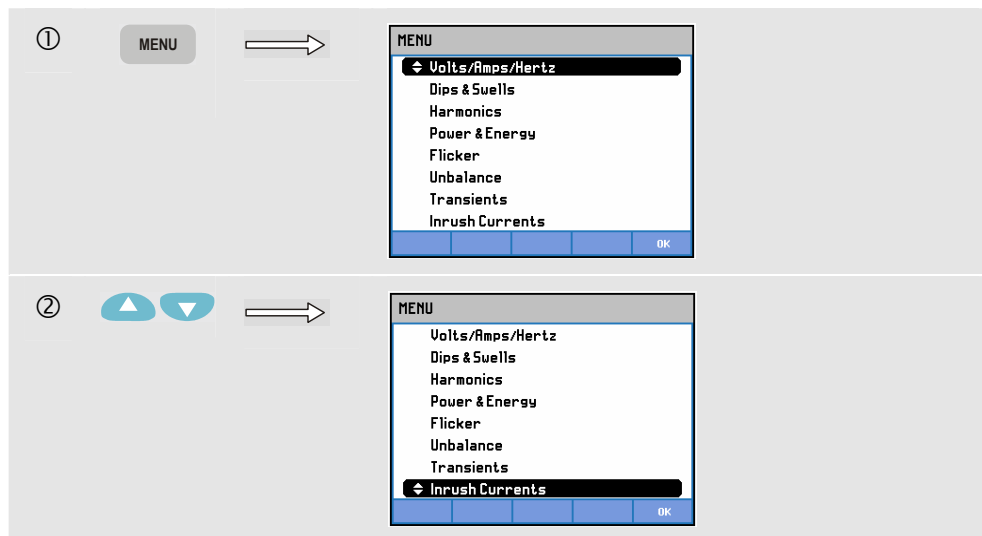

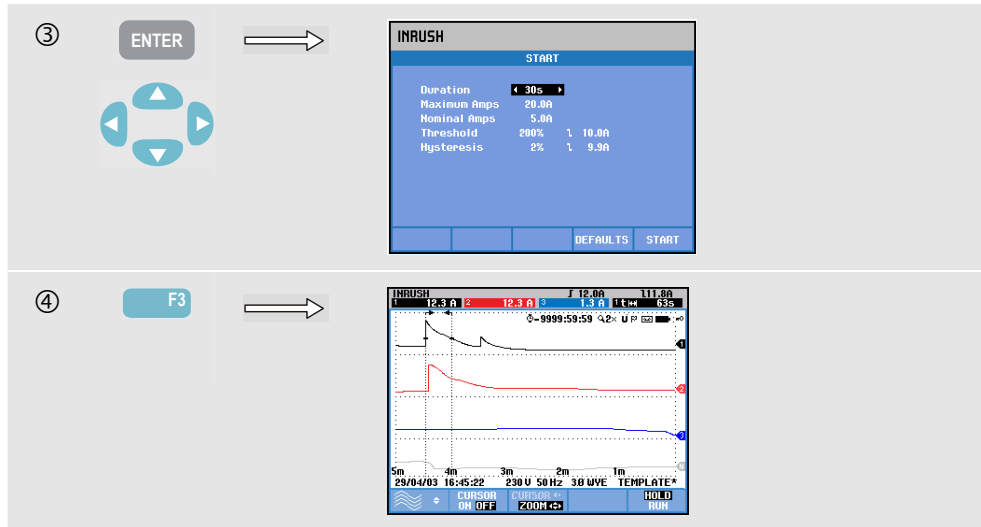

Use the arrow keys in the Start menu to adjust the trigger limits: expected inrush time, maximum current, nominal current, threshold, and hysteresis. The maximum current determines the vertical height of the current display windows. Threshold is the current level that triggers the trend capture. The inrush time is the time between trigger and the time that the current falls to the value indicated by Hysteresis and is indicated on the trend display between two vertical markers. The screen header displays the rms of all rms values during the inrush time. If the Cursor is on, the rms measuring values at the Cursor are displayed.



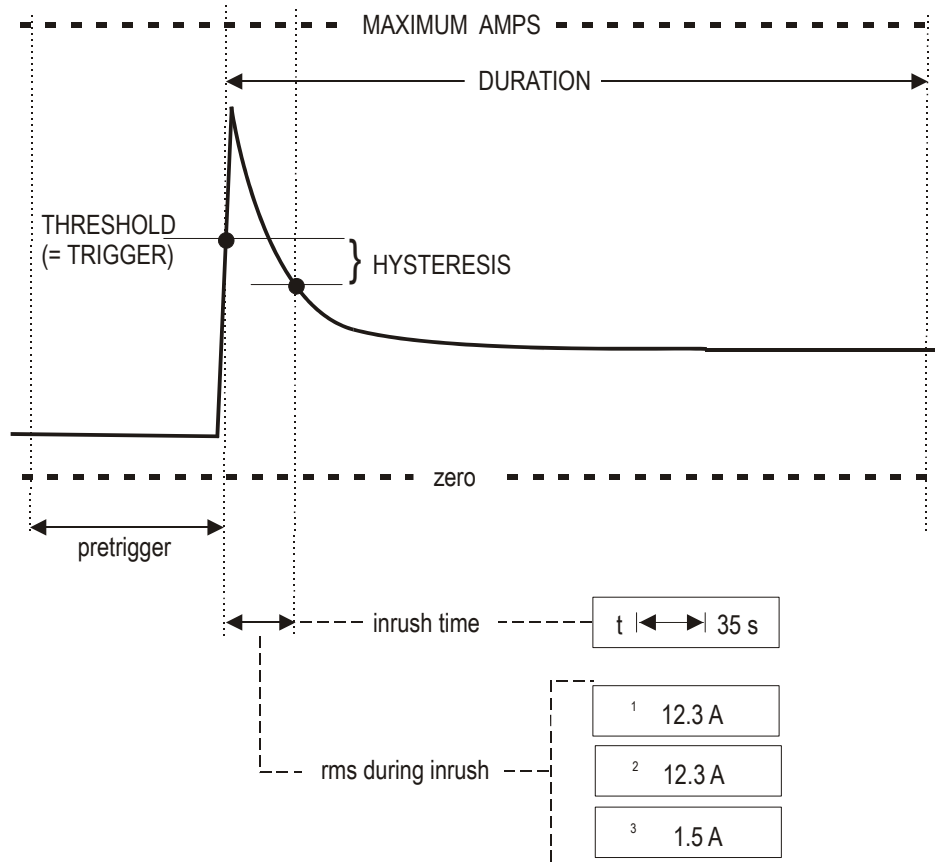

**Figure 15-1. Inrush characteristics and relation with start menu**

Use Cursor and Zoom to investigate details of the recorded Trends. Selection of channels to be displayed is done with the up/down arrow keys. Press function key F1 to assign the arrow keys to this.

Via the SETUP key and function key F3 - FUNCTION PREF you can set up the default values of the trigger limits (expected inrush time, maximum current, nominal current, threshold, hysteresis) and Offset and Span of the Trend display. For detailed information see Chapter 18, FUNCTION PREFERENCEs.

Available function keys:

F1	Assign up/down arrow keys to select a set of trends for display.
F2	Cursor on/off.
F3	Assign arrow keys to Cursor or Zoom operation.
F5	Switch between HOLD and RUN of screen update. Switching from HOLD to RUN invokes a menu to select immediate (NOW) or TIMED start time which allows you to define start and duration of the measurement.

## ***Tips and Hints***

Check the peak currents and their duration. Use the Cursor for readout of momentary values. Check if fuses, circuit breakers, and conductors in the power distribution system can withstand the inrush current during this period. Check also if phase voltages stay stable enough.

High peak currents can cause circuit breakers to trip unexpectedly. Measuring Inrush Current can help in setting trip levels. Since the Analyzer simultaneously captures Inrush Current and Voltage Trends you can use this measurement to check voltage stability as large loads come on line.

# **Chapter 16**

## **Power Quality Monitoring**

### **Introduction**

Power Quality Monitoring or System Monitor displays a Bar graph screen. This screen shows whether important Power Quality parameters meet requirements. Parameters include:

1. RMS voltages
2. Harmonics
3. Flicker
4. Dips/Interruptions/Rapid Voltage Changes/Swells
5. Unbalance/Frequency.

Figure 16-1 shows the screen and its properties.

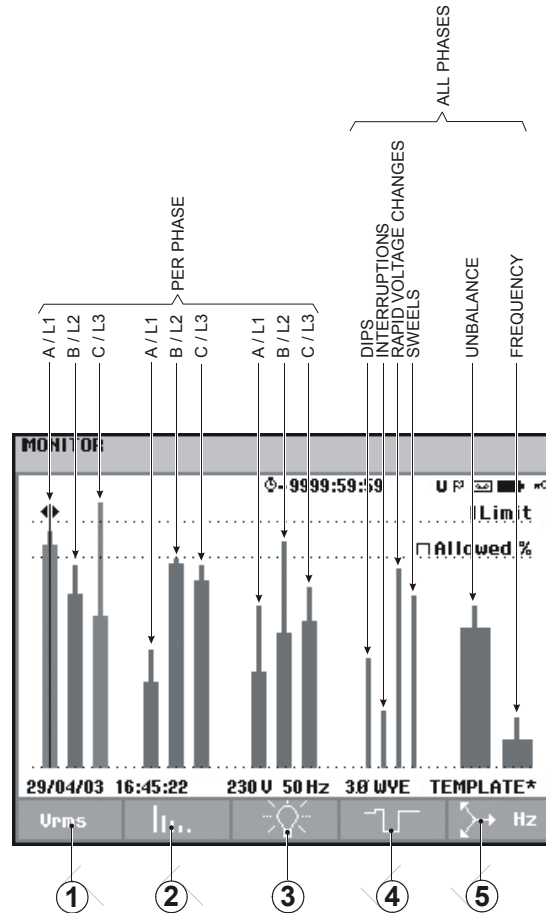

Figure 16-1. Power Quality Monitor Main Screen

The length of a bar increases if the related parameter is further away from its nominal value. The bar turns from green to red if an allowed tolerance requirement is violated.

Use the left/right arrow keys to position the cursor on a particular bar and measuring data belonging to that bar is displayed in the screen header.

Power Quality Monitoring is usually done during a long observation period. The function is entered via the MONITOR key and a start menu to define immediate or timed start of the measurement. Minimum duration of the measurement is 2 hours. An usual measuring period is 1 week.

The Power Quality parameters RMS voltages, Harmonics, and Flicker have a bar for each phase. From left to right these three bars are related to the phases A (L1), B (L2), and C (L3).

The parameters Dips/Interruptions/Rapid Voltage Changes/Swells and Balance/Frequency have a single bar for each parameter representing performance across three phases.

Most of the Bar Graphs have a wide base indicating adjustable time related limits (for instance 95 % of time within limit) and a narrow top indicating a fixed 100 % limit. If one of both limits is violated, the related bar changes from green to red. Dotted horizontal lines on the display indicate the 100% limit and the adjustable limit.

The meaning of the bar graphs with a wide base and a narrow top is explained below. By way of example this is done for the RMS voltage. This voltage for instance has a nominal value of 120 V with a tolerance of + and - 15% (tolerance range between 102 ... 138 V). The momentary RMS voltage is constantly monitored by the Analyzer. It calculates an

average from these measuring values across 10-minute observation periods. The 10-minute averages are compared against the tolerance range (in this example 102 ... 138 V).

The 100 % limit means that the 10-minute averages must always (i.e. 100 % of time or with 100 % probability) be within range. The bar graph will turn to red if a 10-minute average crosses the tolerance range.

The adjustable limit of for instance 95 % (i.e. 95 % probability) means that 95 % of the 10-minute averages must be within tolerance. The 95 % limit is less stringent than the 100 % limit. Therefore the related tolerance range usually is tighter. For 120 V this for instance can be + or – 10 % (a tolerance range between 108 ... 132 V).

The bars for Dips/Interruptions/Rapid Voltage Changes/Swells are narrow and indicate the number of limits violations that occurred during the observation period. The allowed number is adjustable (for instance to 20 Dips/week). The bar turns to red if the adjusted limit is violated.

You can use a pre-defined set of limits or define your own. An example of a pre-defined set is that according to the EN50160 standard. A maximum of 6 sets can be chosen: 2 factory installed sets, 2 sets only definable by the administrator via FlukeView SW43W software, and 2 sets that can be changed on the Analyzer. Selection and definition of limits is accessible via the SETUP key, 'limits' selection and then Function key F3 – EDIT.

The table below gives a survey of the aspects of Power Quality Monitoring:

Parameter	Available Bar Graphs	Limits	Averaging Interval
V rms	3, one for each phase	Probability 100 %: upper & lower limit Probability x %: upper & lower limit	10 minutes
Harmonics	3, one for each phase	Probability 100 %: upper limit Probability x %: upper limit	10 minutes
Flicker	3, one for each phase	Probability 100 %: upper limit Probability x %: upper limit	2 Hrs.
Dips/Interruptions/Rapid Voltage Changes/Swells	4, one for each parameter covering all 3 phases	allowed number of events per week	½ cycle rms based
Unbalance	1, covering all 3 phases	Probability 100 %: upper limit Probability x %: upper limit	10 minutes
Frequency	1, covering all 3 phases Measured on Reference Voltage Input A/L1	* Probability 100 %: upper & lower limit Probability x %: upper & lower limit	10 sec.

## Power Quality Main Screen

To access the Power Quality Main screen:

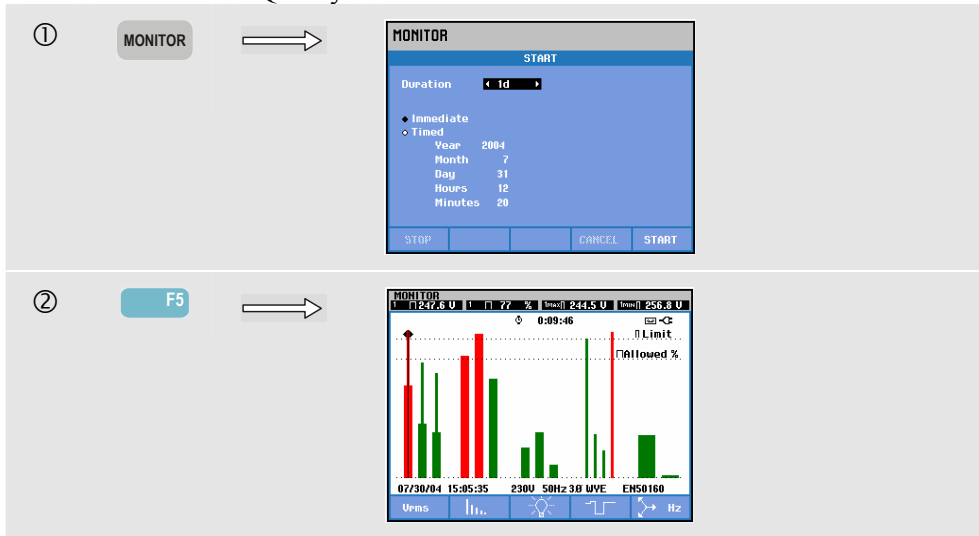

Power Quality Monitoring is reached via the MONITOR key and a menu for Immediate or Timed start. With the left/right arrow keys you can position the Cursor on a particular Bar Graph. Measuring data belonging to the bar is shown in the screen header.

Detailed measurement data is available under the Function keys:

F1	RMS voltage: events table, trends.
F2	Harmonics: bar graphs, events table, trends.
F3	Flicker: events table, trends.
F4	Dips, Interruptions, Rapid voltage changes, and Swells: events table, trends.
F5	Unbalance and Frequency: events table, trends.

The measurement data available under the Function keys is explained in the following sections. Data is presented in the formats Events Table, Trend Display, and Bar Graph Screen.

## Events Table

DATE	TIME	TYPE	LEVEL	DURATION
07/30/04	14:58:09:445	H21	0.7 %	0:00:10:000
07/30/04	14:58:09:445	H22	0.7 %	0:00:10:000
07/30/04	14:58:09:445	H24	0.7 %	0:00:10:000
07/30/04	14:58:09:445	L1	24.9 %	0:00:20:000
07/30/04	14:58:19:445	L1 RMS	263.1 V	0:06:10:000
07/30/04	14:58:49:445	L1 PLT	2.9	0:01:00:000
07/30/04	14:58:49:445	L2 PLT	2.9	0:01:00:000
07/30/04	14:58:49:445	L3 PLT	2.9	0:01:00:000
07/30/04	14:58:19:445	L3 RMS	253.3 V	0:04:00:000
07/30/04	15:02:49:445	L1 PLT	1.1	0:01:00:000
07/30/04	15:02:49:445	L2 PLT	1.1	0:01:00:000

Figure 16-2. Events Table

The events table shows the events that occurred during the measurement with date/time of start, phase, and duration. The amount of information in the table can be selected with the Function keys F2 and F3:

- Selected gives a table with events as selected: Only V rms, Harmonics, Flicker, Dips/Interruptions/Rapid Voltage Changes/Swells, or Unbalance/Frequency. All gives a table with all events. This allows you to see cause and effect of events.
- Normal lists the major event characteristics: start date/time, duration, event type, and magnitude. Detail gives information on threshold crossings for each phase of an event.

The following Abbreviations and Symbols are used in the tables:

Abbreviation	Meaning	Symbol	Meaning
CHG	Rapid Voltage Change	⏏	High value of 100 % limit has been violated
DIP	Voltage Dip	⏏	Low value of 100 % limit has been violated
INT	Voltage Interruption	⏏	High value of x % limit has been violated
SWL	Voltage Swell	⏏	Low value of x % limit has been violated
Hx	Number of the harmonic that violated its limits	⏏	Unbalance event

Available function keys:

F2	Switch between Selected events or All events.
F3	Switch between Normal and Detailed events table.
F4	Access to Trend screen. Two ways to access Trend are explained below.
F5	Return to next higher menu.

Two ways to access Trend:

1. Use the up/down arrow keys to highlight an event in the table. To access Trend press the ENTER key. The Cursor is on, in the mid of screen and located on the selected event. Zoom is set to 4.
2. Press Function key F4 to view the Trend part showing the most recent measuring values. Cursor and Zoom can be switched on afterwards when required.

Measurement specific features:

- V rms events: an event is recorded each time that a 10 minute aggregated RMS value violates its limits.
- Harmonics events: an event is recorded each time a 10 minute aggregated harmonic or THD violates its limit.
- Flicker events: an event is recorded each time Plt (long term severity) violates its limit.
- Dips/Interruptions/Rapid Voltage Changes/Swells events: an event is recorded each time one of the items violates its limits.
- Unbalance, Frequency events: an event is recorded each time that a 10 minute aggregated RMS value violates its limits.

## Trend Display

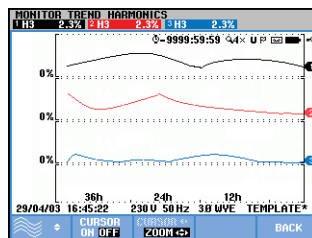

Figure 16-3. Trend Display

The Trend screen shows the changes over time of values in the table. Zoom and Cursor are available to examine Trend details. Zoom and Cursor are operated by the arrow keys and explained in Chapter 17.

Available function keys:

F1	Assign up/down arrow keys to select a set of Trends for display. The selected set is shown in the screen header.
F2	Cursor on/off.
F3	Assign the arrow keys to Cursor or Zoom operation.
F5	Return to events table.



## Bar Graph Screen

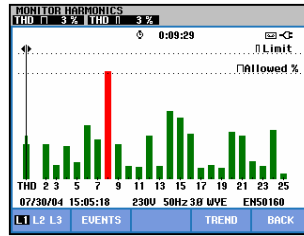

Figure 16-4. Bar Graph Screen

The main system monitor display shows the worst harmonic for each of the three phases. Function key F2 brings up a screen with Bar Graphs showing the percentage of time each phase spent within limits for 25 harmonics and Total Harmonic Distortion (THD). Each Bar Graph has a wide base (representing an adjustable limit of e.g. 95 %) and a narrow top (representing the limit of 100 %). A Bar Graph changes from green to red if the limits for that harmonic are violated.

Cursor: with the left/right arrow keys you can position the Cursor on a particular Bar Graph and measuring data belonging to that bar is shown in the screen header.

Available function keys:

F1	Selection of Bar Graphs belonging to phase A (L1), B (L2), or C (L3).
F2	Access to events table.
F4	Access to Trend screen.
F5	Return to main menu.



# Chapter 17

## Cursor and Zoom

### Introduction

This chapter explains how to use Cursor and Zoom to display and investigate details of Waveform, Trend, and Bar Graph displays. Cursor and Zoom have a certain amount of interaction and are both operated by the arrow keys.

The Cursor is a vertical line that can be positioned on a point on a Waveform, Trend, or Bar Graph. The measured values at that point are displayed in the screen header.

Zoom allows you to stretch and shrink the graph to get a better view of details. Horizontal Zoom is available for Waveform and Trend.

### Cursor on Waveform Displays

As an example the Scope Waveform display is used. Cursor and Zoom for the Transients screen function in the same way.

Figure 17.1 shows the Scope Waveform display with Cursor and Zoom switched off. The screen header shows the RMS values of the displayed waveforms.

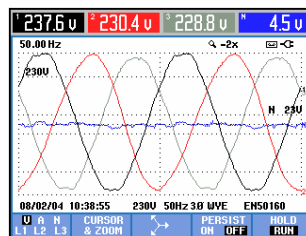

Figure 17-1. Waveform display, no cursor

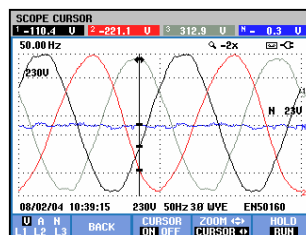

Figure 17-2. Waveform display, cursor on

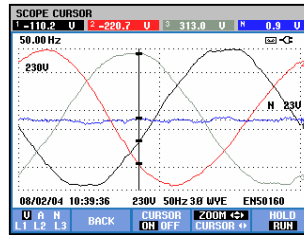

Figure 17-3. Waveform display with cursor and zoom on

Press Function key F2 to obtain a subset with keys to control Cursor and Zoom:

- Press F3 to switch the Cursor on. Use the left/right arrow keys to move the Cursor horizontally along the waveforms. The value of the waveforms at the Cursor is displayed in the screen header as shown in Figure 17.2.
- Press F4 to assign the arrow keys to Zoom operation as shown in Figure 17.3. The left/right arrow keys can be used now to stretch or shrink the waveforms horizontally. The up/down arrow keys do this in vertical direction. If the Cursor is on, horizontal zoom operates symmetrically around the Cursor. When off, horizontal zoom operates around the screen center. Vertical zoom operates around the screen center.
- Press F4 again to assign the arrow keys to Cursor operation.
- With F2 you can return to the previous menu.

## Cursor on Trend Displays

As an example the Volts/Amps/Hertz Trend display is used. Cursor and Zoom for other Trend displays function in the same way.

Figure 17.4 shows the Trend screen with Cursor and Zoom switched off. The screen header displays RMS values of the Trends at the right screen side. This is the screen side with the most recent measuring values.

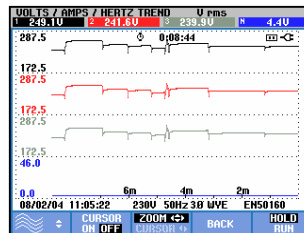

Figure 17-4. Trend display, no cursor

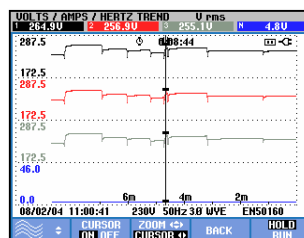

Figure 17-5. Trend display, cursor on

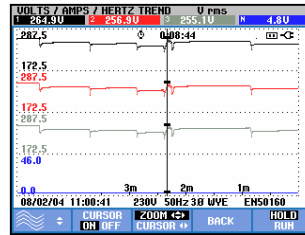

Figure 17-6. Trend display with cursor and zoom on

The Function keys F1, F2, and F3 and the arrow keys are used to operate Cursor and Zoom:

- Operate F2 to switch the Cursor on. Use the left/right arrow keys to move the Cursor horizontally along the trends. The value of the trends at the Cursor is displayed in the screen header as shown in Figure 17.5. Observe that the screen update stops now (recording of data continues!). Trend can record a maximum of six screens of which one is displayed at a time. Positioning the Cursor across the left or right screen end brings the next screen within the viewing area.
- Press F3 to assign the arrow keys to Zoom operation. The left/right arrow keys can be used now to stretch and shrink the trends horizontally as shown in figure 17.6. The up/down arrow keys do this in vertical direction. If the Cursor is on, horizontal zoom operates symmetrically around the Cursor; when off horizontal zoom operates from the right screen side. Vertical zoom operates around the screen center.
- Press F1 to assign the arrow keys to select the Trend line(s) to be displayed.
- Press F3 again to assign the arrow keys to Cursor operation.

### From Events Table to Trend Display with Cursor On.

Within an events table, you can highlight a certain event with the up/down arrow keys. Next press the ENTER key. As a result a Trend display is shown with the Cursor on and positioned on the highlighted event. The steps in this process are shown below.

The example below shows the transition from Dips & Swells events table to trend display with cursor on:

①

⇒

**DIPS & SWELLS EVENTS**

START 08/02/04 11:29:34      EVENT 4 / 7

DATE	TIME	TYPE	LEVEL	DURATION
08/02/04	11:30:29:410	L1 SWL	253.4 U	0:00:00:080
08/02/04	11:30:29:080	L1 SWL	270.3 U	0:00:35:235
08/02/04	11:31:04:595	L1 SWL	260.0 U	0:00:00:391
08/02/04	11:31:05:855	L1 SWL	253.1 U	0:00:00:040
08/02/04	11:32:53:021	L1 SWL	253.8 U	0:00:00:069
08/02/04	11:32:53:241	L1 SWL	257.0 U	0:00:00:320
08/02/04	11:32:54:151	L1 SWL	271.1 U	0:03:01:356

08/02/04 11:40:59      230U 50Hz 30 UVE      ENS0160

NORMAL    BACK    TREND

Use the arrow keys to highlight an event of interest.

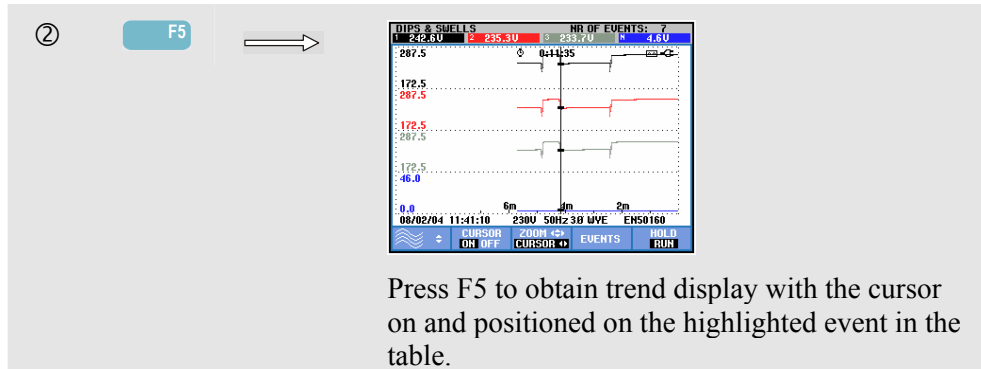

## Cursor on Bar graph Displays

As an example the Three-phase Voltage Harmonics display as shown in Figure 17.7 is used. Cursor and Zoom for other Bar Graph displays function identically.

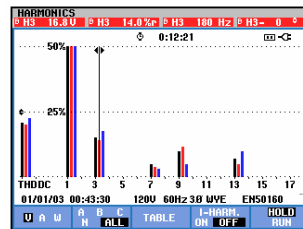

Figure 17-7. Cursor on bar graphs

On Bar Graph displays the Cursor is always on. Cursor and Zoom are operated with the arrow keys:

- Use the left/right arrow keys to position the Cursor on a certain bar. The header shows relevant measuring data belonging to the bar. In certain cases there are more bars available than can be displayed in one screen. In the figure for instance 17 harmonics out of a total of 51 are displayed. Positioning the Cursor across the left or right screen end brings the next screen within the viewing area.
- Use the up/down arrow keys to stretch (or shrink) the Bar Graphs vertically.

# Chapter 18

## Setting up the Analyzer

### Introduction

The SETUP key accesses menus to view and change Analyzer settings. At delivery the Analyzer is adjusted to settings that match your local situation and the supplied accessories. The table below gives an overview:

Setting	Preset Value
Nominal Voltage	120 V or 230 V
Nominal Frequency	60 Hz or 50 Hz
Displacement Power Factor	DPF or Cos $\phi$
Phase Identification	A,B,C or L1,L2,L3
Phase Colors A/L1-B/L2-C/L3-N-Ground	Black-Red-Blue-Gray-Green or Black-Red-Gray-Blue-Green/Yellow or Red-Yellow-Blue-Black-Green/Yellow or Black-Black-Black-Blue-Green/Yellow
Date Format	Month/Day/Year or Day/Month/Year

If desired the settings in the table can be changed by the user.

Also other settings such as offset and span of trend and waveform displays are set to Factory Default values. This will give good readings in almost all situations and allows you to start measurements almost immediately.

At power-on a welcome screen is displayed that shows settings currently in use. Check if Date and Time of the system clock are correct. Also the wiring Configuration must match the configuration of the power system to be checked. The wiring Configuration is available under Function key F1.

If necessary adjust Date, Time, and Config. How to do this is explained in section 'General Settings'. The welcome screen is shown in the Figure below.

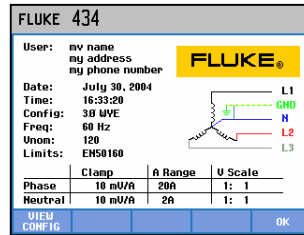

Figure 18-1. Welcome screen at power-on

The Settings are grouped in four functional sections and are explained accordingly in four sections of this manual chapter:

- *General Settings*: Date, Time, wiring Configuration, nominal Voltage, nominal Frequency, current and voltage probe type, information language, survey and installation of options.
- *FUNCTION PReFerences*: adjustment of Offset and Span of Trend and Waveform displays, contents of harmonics table and harmonics settings, power settings, flicker D-parameter settings, Inrush defaults, and Transient settings. Function key F4 in these menus gives a reset to factory default settings. Default settings usually give a good display.
- *USER PReFerences*: adjustment of Phase Identification and Colors, Printer and RS-232 settings, Auto shut-off, definition of User name (as shown in entry screen), and display contrast. Many menus have a function key for reset to factory default settings.
- *Limits Settings*: for save, recall, and definition of the limits for power quality monitoring.

The figure below shows the entry menu present under the SETUP key.

Entering the Setup menu:

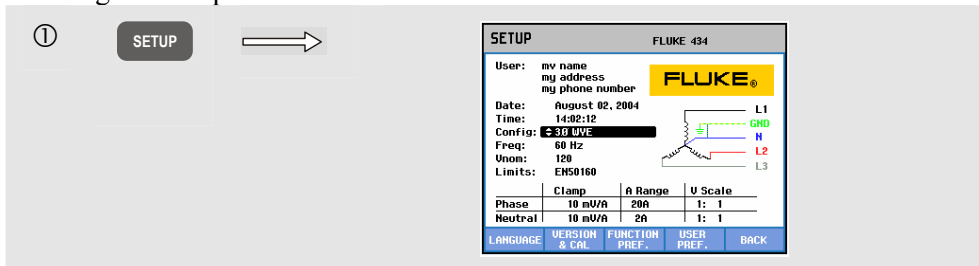

Menu navigation and selections:

	Selection of the item to be adjusted.
	Press to access the selected settings menu.
	To select (up/down) and adjust (left/right) items in a settings menu.
	Confirm the selection and return to previous menu.



## General Settings

To access the General Settings menus:

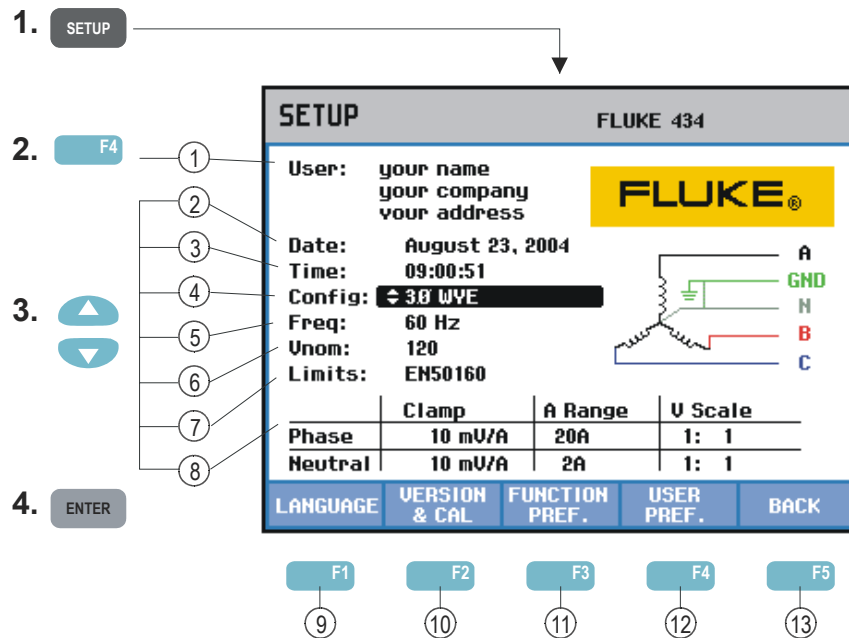

The actual settings are shown in the SETUP entry screen. Use the key operations described above to change an item.

Read below how to make adjustments:

- ① User name/address: see section USER PReFerences.
- ② Date: Use the up/down arrow keys to adjust the date and its representation MM/DD/YY (Month/Day/Year) or DD/MM/YY (Day/Month/Year). Press ENTER to confirm the selection and Function key F5 – OK to return to the previous menu.
- ③ Time: Use the up/down arrow keys to select Hours (24 hour system), Minutes, Seconds and the left/right arrow keys to adjust each item. Press Function key F5 – OK to confirm.
- ④ Config: selection of 4 wiring configurations. Function key F1 – MORE accesses the next menu with 4 other configurations. Press Function key F5 – OK to confirm and to enter a screen showing how to connect the Analyzer to the power system. When ready press Function key F5 to return to the SETUP entry screen.
- ⑤ Vnom: adjustment of Nominal Voltage. Use the arrow keys to select 100 V, 120 V, 230 V, 400 V or any desired value. Press Function key F5 – OK to confirm.

- ⑥ Freq: adjustment of Nominal Frequency. Use the up/down arrow keys to select 60 or 50 Hz. Press Function key F5 – OK to confirm.
- ⑦ Limits: see section Limits Settings.
- ⑧ Clamp, A range, V scale: adjustment of the Analyzer to the characteristics of current clamps and voltage leads. The default selection is valid for the accessories as supplied with the Analyzer. The supplied voltage leads are 1:1 types; when using attenuating leads or a voltage transformer you must adapt the voltage scale accordingly (e.g. 10:1 for 10 times attenuation). There are separate selection tables for the Phases and Neutral: Function key F3 is used for selection.
- ⑨ F1 – LANGUAGE: use the up/down arrow keys to select the desired information language. Press Function key F5 – OK to confirm.
- ⑩ F2 – VERSION & CAL: access to a read-only menu showing Model Number, Serial Number, Calibration Number, Calibration Date, and a survey of installed Options. The submenu under F1 is used to activate options. Chapter 20 Tips and Maintenance explains how to do this.
- ⑪ F3 – FUNCTION PREF.: see section FUNCTION PREFERENCE.
- ⑫ F4 – USER PREF.: see section USER PREFERENCE.
- ⑬ F5 – BACK: return to last active measuring mode.

Below you will find a step-by-step example on how to change wiring configuration to 3-phase Wye IT (IT = Interrupted Terra = Interrupted Ground).

① **SETUP** →

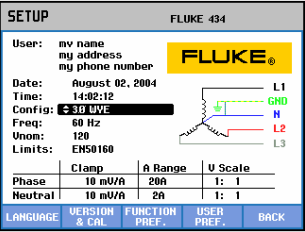

The active configuration is indicated behind Config. Config is highlighted indicating that this item can be adjusted when you press the ENTER key. The belonging configuration symbol is shown on the right side of the screen.

② **ENTER** →

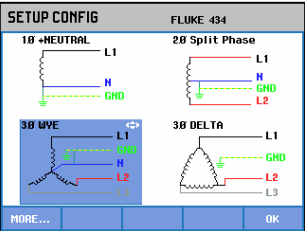

The screen shows 4 wiring configurations; 3-phase Wye IT configuration is not among them. Press F1 to access a second screen with 4 other configurations.

③ **F1** →

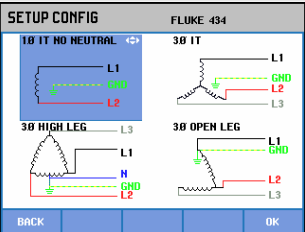

The second screen incorporates 3-phase Wye IT (3φ IT) configuration.

④ **Arrow Keys** →

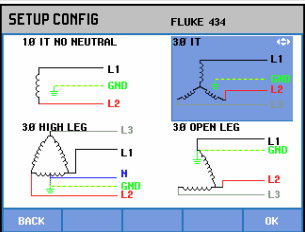

Use the arrow keys to highlight 3φ IT. Press F5 to confirm the selection.

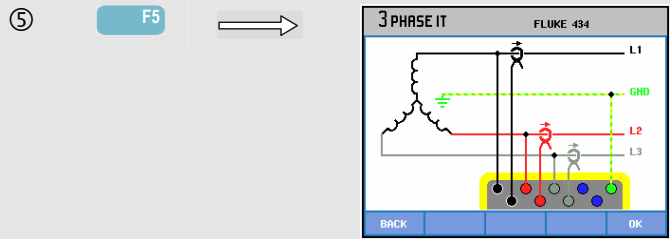

An information screen shows up that informs you on how to connect the Analyzer to the power system under test. When done press F5.

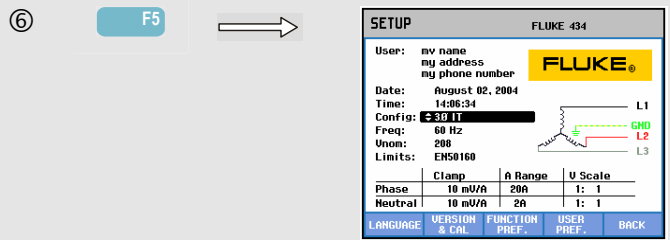

Return to Setup entry screen. The new configuration is indicated behind Config. and the belonging configuration symbol is shown on the right side of the screen.

## FUNCTION PReferences

To access the FUNCTION PReferences menus:

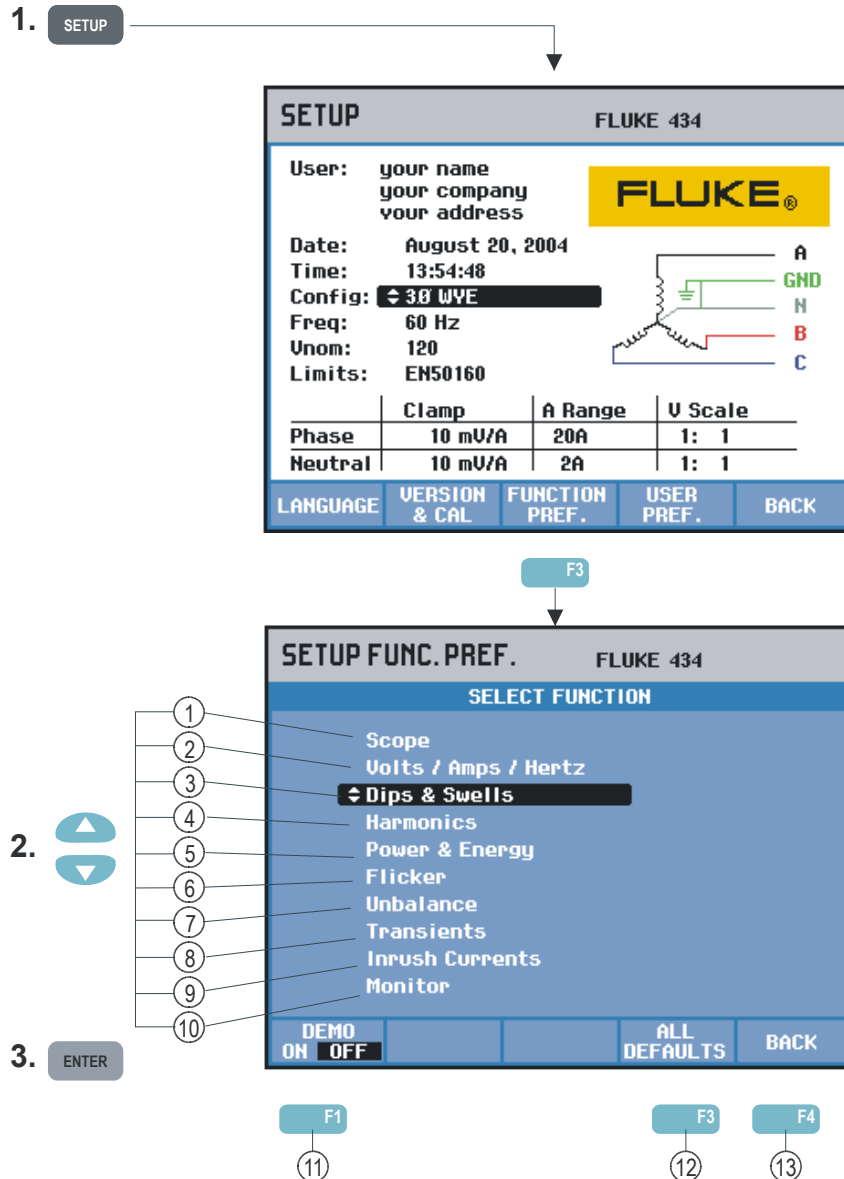

FUNCTION PReferences allows you to customize data presentation of measuring functions. This concerns for instance Offset and Span of Trend and Waveform displays. The table below gives a survey adjustable items for each function. A measuring function stays active while you adjust its settings. This allows you to directly judge the result of the adjustment.

Some items have separate adjustments for Phase and Neutral. Function key F3 is used to switch Phase and Neutral adjustments.

For each measuring function a set of default settings is available giving good data presentation under most circumstances. Press F4 – DEFAULT to restore this set.

Measuring Function/ Screen Type	Measuring Data to be adjusted	Settings Type
1. Scope Waveform	Volt, Amp (separate for Phase and Neutral)	Range
2. Volts/Amps/Hertz Trend	Volt (Peak), Amp (Peak), CF, (separate for Phase and Neutral), Hz	Offset + Span (2 screens)
3. Dips & Swells Trend	Volt, Amp (separate for Phase and Neutral)	Offset + Span
4. Harmonics Table	Harmonics to be displayed, THD, DC, V, A, W, V&A, %r (of rms) / %f (of fundamental)	Harmonic order
Trend	Harmonics, THD, DC	Offset + Span
5. Power & Energy Trend	W, VA, VAR, PF, DPF/cos $\Phi$ , Vrms, Arms (separate for Phase and Neutral)	Offset + Span (2 screens)
	Demand Interval, kWh/pulse, DPF/cos $\phi$ , FULL/FUNDamental	To customize measurements
6. Flicker Trend Function	Pst, Plt, Dc, Dmax, Td<%, PF5 D-parameter Settings	Offset + Span Steady time, Steady Tolerance, Threshold
7. Unbalance Trend	Unbal V, Unbal A, V, A, Hz, $\phi$ V-V, $\phi$ V-A (separate for Phase and Neutral)	Offset + Span (2 screens)
8. Transients Waveform	V, A (separate for Phase and Neutral)	Span
Function	Trigger conditions	V/A level + type of trigger
9. Inrush Trend	A, V(separate for Phase and Neutral)	Offset + Span
Function	Trigger conditions	Current characteristics
10. Monitor Trend Vrms	V, A (separate for Phase and Neutral)	(2 screens) Offset + Span
Trend Harmonic	Number	Offset + Span
Flicker Trend	Pst, Plt	Offset + Span
Unbalance Trend	Percentage	Offset + Span
Frequency Trend	Hz	Offset + Span

Available function keys:

⑪ F1 - DEMO mode: the input sensitivities are increased to 2 V for use with a demo generator. The generator is capable to generate 3-phase voltages and currents with various interference types.

⑫ F4 - ALL DEFAULT: resets all settings in this menu to factory default.

⑬ F5 - BACK: return to SETUP entry menu.

The example below shows stepwise how to adjust offset and span of a Volts/Amps/Hertz trend after a voltage change has occurred.

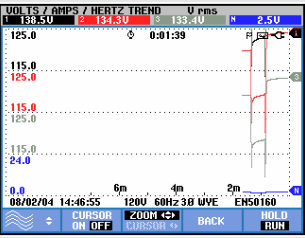
① 

Trends are outside their window.

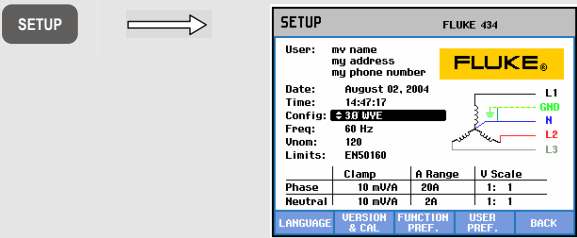
② 

Press SETUP to access setup entry screen.

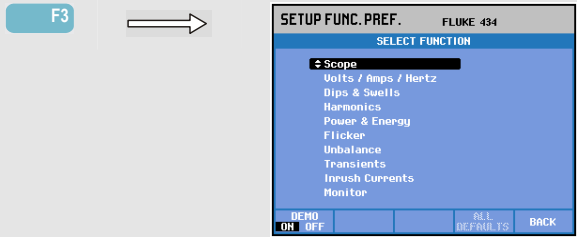
③ 

Press function key F3 to access select function screen.

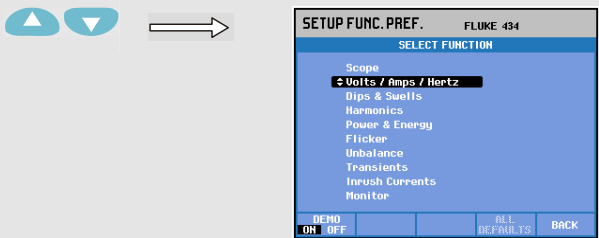
④ 

Select Volts/Amps/Hertz with the up/down arrow keys.

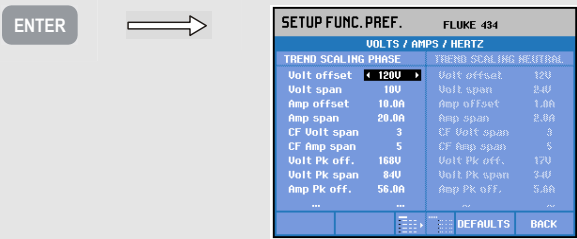
⑤ 

Press the ENTER key to access trend scaling.

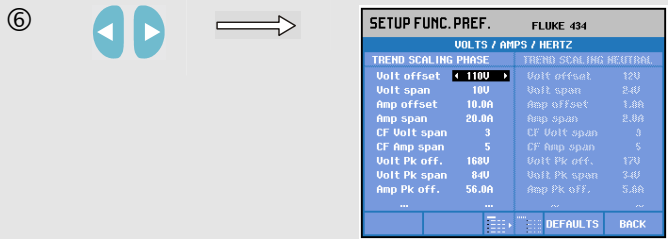

Use the left/right arrow keys to decrease the Voltage offset.

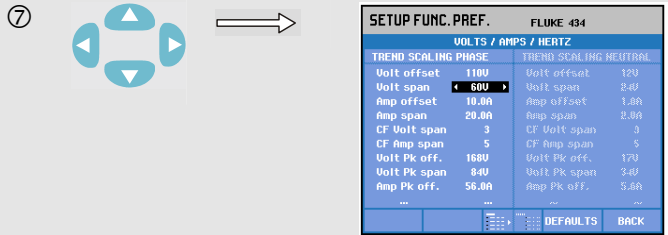

Use the up/down arrow keys to select Volt span adjustment. Use the left/right arrow keys to increase the Voltage span.

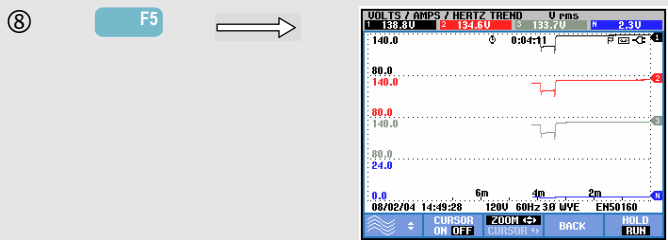

Press function key F5 three times to return to the Volts/Amps/Hertz trend screen with new offset and span. The trends are inside their window now.



## USER PReFerences

To access the USER PReFerences menus:

1. **SETUP**

2. **UP/DOWN ARROWS**

3. **ENTER**

F1 (6) F2 (7) F3 (8) F4 (9)

USER PReFerences allows you to customize Phase Identification and Colors, Printer and RS-232 settings, Auto shut-off, definition of User name/address (as shown in entry screen), and display contrast. Many menus have a function key to reset to factory default settings.

Read below how to make adjustments:

- ① Phase Identification: Use the up/down arrow keys to select A, B, C or L1, L2, L3. Press Function key F5 – OK to confirm.

- ② Phase Colors: use the function keys F1 ... F4 to choose colors as used in the USA, EU, UK, or according to IEC. Or define your own set of colors: use the up/down arrow keys to select a phase and use the left/right arrow keys to select a color. Press function key F5 – OK to confirm.
- ③ Printer: Use the arrow keys to select and adjust baudrate for use with a printer. Use the up/down arrow keys to select the printer type. Press function key F5 – OK to confirm.
- ④ RS-232: Use the left/right arrow keys to adjust communication baudrate (for communication with a PC).
- ⑤ Battery save/Auto-OFF: Use the up/down arrow keys to select the time after which the Display switches off when no keys are operated.
- ⑥ F1 – FACTORY DEFAULTS: resets all settings in this menu to factory default.
- ⑦ F2 – USER ID: access to a menu to define 3 lines with user programmable text (e.g. the owner's name and address). This text appears in the power-on and SETUP entry screens. Use Function key F3 to insert spaces. Press function key F5 – OK to confirm.
- ⑧ F3 – CONTRAST: Use left/right arrow keys to adjust the display contrast.
- ⑨ F5 – BACK: return to SETUP entry menu.

## Limits Adjustments

To navigate the Limits Setup menus:

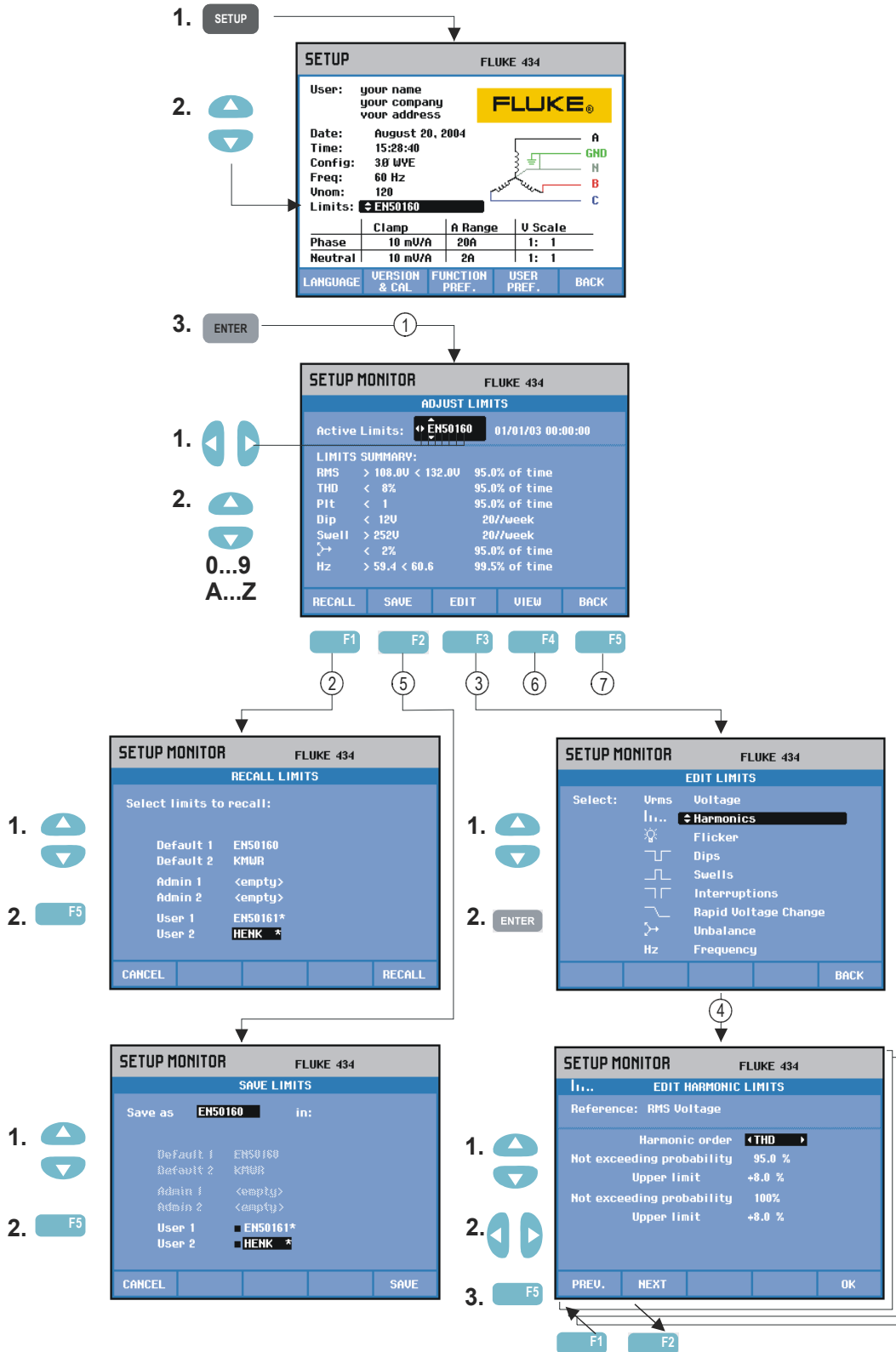

Limits Adjustments is used to save, recall, and define sets of limits for:

- Power Quality Monitoring.
- Dips/Interruptions/Rapid Voltage Changes/Swells.

Read below how to do this:

- ① Adjust Monitor Limits is the entry menu. It shows the main settings of the active set of limits: name, creation date, and a summary of limits data.  
If required, use the arrow keys to define a name for a set of limits that you want to save.
- ② Recall Monitor Limits menu is used to recall a set of power quality limits. A maximum of six sets can be recalled:
  - Default 1 and 2 are factory installed read-only sets: one of them is the set of limits according to the EN50160 standard.
  - Admin 1 and 2 are sets definable by an administrator by means of PC-software: for the user these sets are read-only.
  - User 1 and 2 can be defined and saved by the user.Use the up/down arrow keys to select a set of limits you want to recall. Then press Function key F5 to recall and to use them. Press Function key F1 to leave the menu without further actions.
- ③ Edit Monitor Limits menu is used to modify limits. Setups are grouped per power quality item in separate submenus for voltage, harmonics, flicker, etc.  
Use the up/down arrow keys to select an item to be adjusted. Then press the ENTER key F5 to enter the adjustment submenu. All adjustment items are listed in the table below.
- ④ Use the arrow keys to select and edit limits.  
Press Function key F5 to confirm selections and return to the Edit Limits menu. Use Function keys F1 – PREVIOUS or F2 – NEXT to move directly to an adjacent submenu. When ready with editing the limits, Press Function key F5 – OK twice to return to the Adjust Monitor Limits menu. Arrow keys can be used here to define a name for the new set of limits. Then press Function key F2 – SAVE to enter the Save Monitor Limits menu.
- ⑤ Save Monitor Limits menu is used to save sets of limits in User 1 or 2. Use the up/down arrow keys to select User 1 or User 2. When available save the set of limits in an empty location; saving into a location already filled will overwrite the existing set. Press Function key F5 – SAVE to do the save action. Press F1 – CANCEL to return to the Adjust Monitor Limits menu without saving limits. In this menu you can also define a name for a set of limits to be saved.

- ⑥ View Monitor Limits menu. This menu has the same structure as the Edit Monitor Limits menu and can be used to view limits without the risk of changing them.
- ⑦ Press Function key F5 – BACK to return to the SETUP entry menu.

Setup of Monitor Limits, a survey of adjustments.

Limits	Adjustments
Voltage	2 Probability percentages (100 % and adjustable): each with adjustable upper and lower limit.
Harmonics	For each harmonic 2 Probability percentages (100 % and adjustable): each with adjustable upper limit.
Flicker	Weighing curve (lamp type). 2 Probability percentages (100 % and adjustable): adjustable percentage with adjustable upper limit.
Dips (*)	Reference voltage (Nominal or Sliding). Threshold, hysteresis, allowed number of dips/week.
Swells (*)	Reference voltage (Nominal or Sliding). Threshold, hysteresis, allowed number of swells/week.
Interruptions (*)	Threshold, hysteresis, allowed number of interruptions/week. Reference voltage is Nominal.
Rapid Voltage Changes (*)	Voltage tolerance, Steady time, Minimum step, Minimum rate (V/s), allowed number of events/week.
Unbalance	For each harmonic 2 Probability percentages (100 % and adjustable): adjustable percentage with adjustable upper limit.
Frequency	2 Probability percentages (100 % and adjustable): each with adjustable upper and lower limit.

(\*): setups that are also valid for measuring mode Dips & Swells. Events per week is used for Monitor only.



# Chapter 19

## Using Memory, Printer, and PC

### Introduction



This chapter explains how to save screens and data into the Analyzer's memory and how to view, rename and delete them.

The second part of the chapter explains how to setup the Analyzer for communication with a PC, laptop, and printer.

Note: the Analyzer also has memories to store setups. How to change, save, and recall setups is explained in Chapter 17 Setup.

### Using memory

The Analyzer has two ways of storing measuring results into memory:

1. A copy of the current screen can be stored. A maximum of 50 screenshots can be saved in **Fluke 434** and 25 in Fluke 433. Symbol for screenshots: 
2. The complete dataset belonging to the current measurement can be saved. A dataset includes all data belonging to the measurement. This allows you to view and analyze all screens belonging to the measurement, and to use Cursor and Zoom. A maximum of 10 datasets can be saved in **Fluke 434** and 5 in Fluke 433. Symbol for datasets: 

### Making a Screenshot



Press this key to make a screenshot.

Making a screenshot is a quick and easy way to store measuring results. However post processing is not possible. A screenshot is saved each time you press this button. A screenshot is saved as a file with date and time when saved. This occurs via a menu to define a name for the file to be saved.

Name definition is done with the arrow keys: the up/down keys for character selection and the left/right keys for character position. Spaces are inserted with Function key F3. How to recall, print, and delete screenshots and how to rename them is explained in the next section 'Memory Operations'.

## Memory Operations

The MEMORY button accesses menus to save, recall, view, delete and print datasets and screenshots. When you press the MEMORY button, the current measurement screen is frozen.

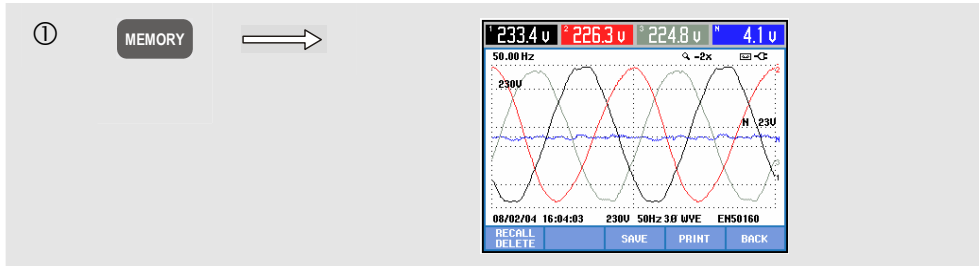

Available function keys (in the sequence they are normally used):

F3	SAVE. All data belonging to the measurement is saved in memory. This occurs via a menu to define a name for the file to be saved. Name definition is done with the arrow keys: the up/down keys for character selection and the left/right keys for character position. Spaces are inserted with Function key F3. Date and time of the save action are derived from Analyzer's real time clock.
F4	PRINT. Press to print the current screen. Section 'Using Printer and PC' explains the Analyzer setup.
F5	BACK. Press to resume the measurement.
F1	RECALL / DELETE. Accesses the submenu to view, delete, rename files and to use datasets. The submenu is shown in the figure below: it lists all screen shots and data sets in the sequence of date and time. The type column indicates screen shots with a small symbol (📷) and datasets with a larger symbol (📄). You can use the up/down arrow keys to highlight a particular to be viewed.

Recalling and deleting Screenshots and Datasets:

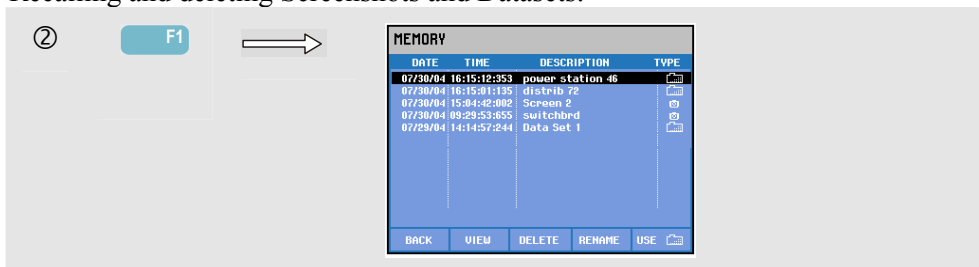



Available function keys for recall and delete:

F1	Return to main menu.
F2	Access to the menu where you can view the highlighted screen shots and data sets. Use the Function keys PREVIOUS or NEXT to view other files. Files are grouped in sequence of date and time. For data sets the entry screen is shown. Complete data within a data set becomes available for investigation after you have pressed USE.
F3	To delete the file highlighted with the up/down arrow keys.
F4	To rename the file highlighted with the up/down arrow keys. Renaming occurs via a menu to define a new name. Name definition is done with the arrow keys: the up/down keys for character selection and the left/right keys for character position. Spaces are inserted with Function key F3. The selection is confirmed with Function key F5.
F5	Is only available for datasets to view their complete contents.

## Use of Printer and PC

The Analyzer is equipped with an optical RS-232 interface for communication with a PC or printer. To make the connection with the USB port of modern PC's an optical interface cable model OC4USB is supplied with **Fluke 434**. With the FlukeView software as supplied with **Fluke 434** you can upload waveform data and screenshots in bitmap format to your PC or laptop. The information supplied with FlukeView software informs you about its features. The interface connection is located at the right Analyzer side and attainable if the tilt stand is folded out. For Fluke 433 the interface cable and FlukeView software can be ordered as an option.

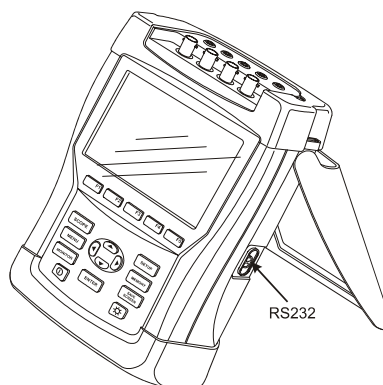
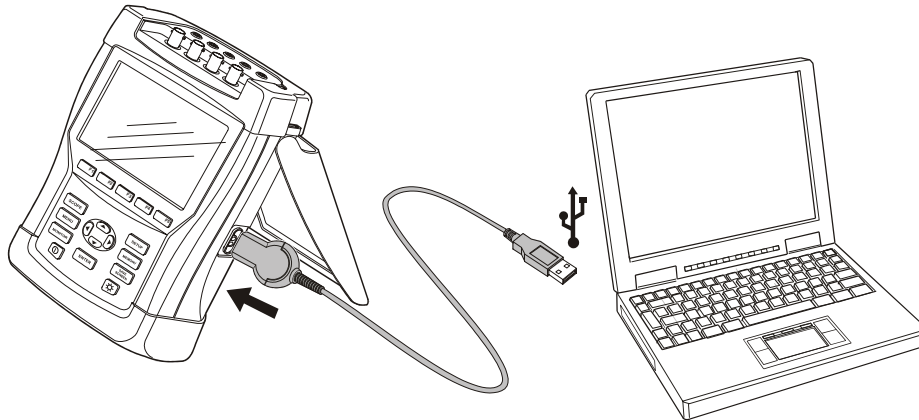

Figure 19-1. Location of optical interface

When started, FlukeView software scans the PC ports to find the connected Analyzer. It is not necessary to adjust baudrate of PC and Analyzer.

For other applications communication baudrate can be adjusted as follows: press the SETUP key, then Function key F4 – USER PREFERENCE, and then select RS-232 using

the up/down arrow keys and ENTER. Then adjust the baudrate with the left/right arrow keys and leave the menu with F5 - BACK. Baudrate and COM port number in FlukeView must be adjusted correctly.



**Figure 19-2. Analyzer and laptop PC**

For correct communication with a printer it is necessary that baudrate and printer type of Analyzer match with the hard copy device. The Analyzer baudrate and printer type are adjustable as follows: press the SETUP key, then Function key F4 – USER PREFERENCE, and then select Printer using the up/down arrow keys and ENTER. Then adjust the baudrate with the left/right arrow keys, adjust the printer type with the up/down arrow keys and confirm with ENTER. Leave the menu with F5 - BACK.

The figure below shows a typical setup with printer DPU-414 and printer adapter cable PAC91. This setup requires an Analyzer baudrate of 9600 baud.

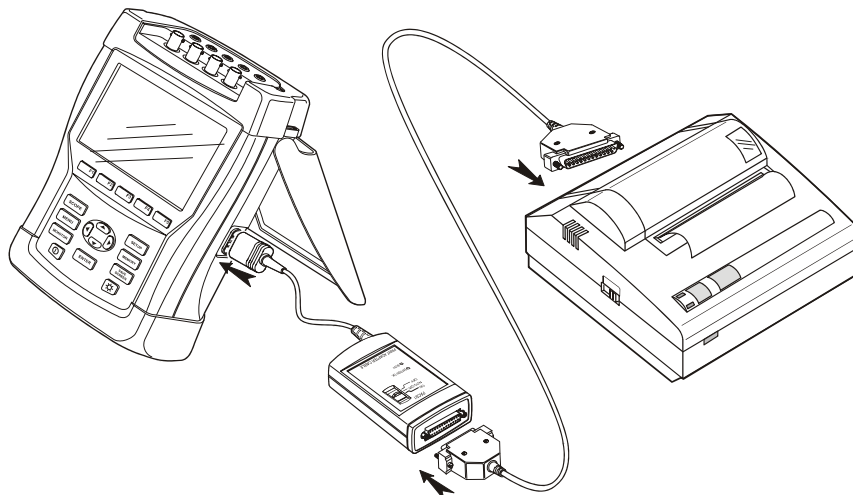

**Figure 19-3. Analyzer, printer DPU-414, and printer adapter cable PAC91**

*Note*

*The Analyzer is adjustable to different baudrates for PC and printer.*

# Chapter 20

## ***Tips and Maintenance***

### ***Introduction***

This chapter covers basic maintenance procedures that can be performed by the user. For complete service, disassembly, repair, and calibration information, see the Service Manual. You will find the part number of the Service Manual in section ‘Parts and Accessories’ in this chapter.

### ***Cleaning the Analyzer and its Accessories***

Clean the Analyzer and accessories with a damp cloth and a mild soap. Do not use abrasives, solvents, or alcohol. These may damage the text.

Additional to this it is recommended to open the jaws of the Current Clamp and to wipe the magnetic pole pieces with a lightly oiled cloth. This in order to avoid rust or corrosion to form on the magnetic poles.

### ***Storing the Analyzer***

Before storing the Analyzer for an extended period of time, fully charge the NiMH battery.

### ***Keeping the Battery in Good Condition***

When the Analyzer is powered by the battery, the battery condition symbol in the screen header informs you about the charge condition. This symbol ranges from fully charged to empty: ■ ■ ■ ■ □ ☒

To keep the battery in optimal condition, you must let it discharge fully and then charge it. A full charge takes 4 hours with the Analyzer turned off. Repeat this at least twice a year.

### ***Installation of Options in Fluke 433***

The Advanced Functions Interharmonics, Transients, Energy Usage, Inrush Currents, and extra memory as available in Fluke 434, can be activated in an existing Fluke 433. Activation can be done by the user done via a pin-code that is unique for the serial number of your Analyzer. The code is supplied by Fluke. Contact your Fluke sales representative for details on how to obtain your pin-code.

Proceed as follows to activate the Advanced Functions:

- Press the SETUP key to enter the SETUP entry menu.
- Press Function key F2 to enter the VERSION & CALIBRATION menu. This read-only menu indicates the options already activated. Also the date of the last instrument calibration is indicated in the menu.
- Press Function key F1 to enter the INSTALL OPTION menu.
- Enter the pin-code with the arrow keys: use left/right keys to select the position and the up/down keys to define the number.
- Press ENTER to confirm the selection and to activate the option. The menu now will show INSTALLED behind the option just activated.

For your Fluke 433 you can also order an Upgrade Kit. The kit includes access to install the Advanced Functions and also FlukeView software and an optical interface cable.

*Note:*

*The VERSION & CALIBRATION menu indicates the last calibration date. For this Analyzer a calibration interval of 1 year is recommended. Contact your authorized Fluke Service Center if the calibration interval has been expired.*

## **Parts and Accessories**

### **Standard Accessories.**

The following tables list the user-replaceable parts. For additional optional accessories, see the ScopeMeter Accessories brochure. To order replacement parts or additional accessories, contact your nearest Fluke Service Center.

Item	Ordering Code
Battery Charger / Power Adapter	BC430
Test Lead Set 2.5 m incl. Alligator Clips (5 pieces).	TLS430
AC Current Clamp Set (4 pieces): 400 A (1 mV/A) and 40 A (10 mV/A) switchable.	i400s
Set with Color Coding Clips for Test Leads	0040 244 00071
Decal Set for Input Sockets, Colored	0040 241 00411
Decal Set for Input Sockets, Black & White	0040 241 00401
Optical Cable for USB	OC4USB
Hard Case	C430
Hang Strap	946769
CD-ROM with Users Manuals and Getting Started Manuals (multi-language)	0040 247 00021
Getting Started Manual (printed versions):	
- English, French, Spanish, Portuguese	4822 872 30755
- English	4822 872 30756
- English, French, German, Spanish, Italian	4822 872 30757
- English, Russian, Japanese, Chinese, Korean	4822 872 30758

**Optional Accessories.**

Item	Ordering Code
Advanced Functions for Fluke 433 (Interharmonics, Transients, Energy Usage, Inrush Currents, Extra Memory).	Fluke-433/AF
FlukeView Software for Fluke 433	SW43W (V3.0)
Upgrade Kit for Fluke 433 (Advanced Functions, FlukeView Software, Optical Cable for USB model OC4USB)	Fluke-433/UGK
Optical Isolated RS-232 Cable	PM9080
Print Adapter for Parallel Printers	PAC91
Optical Isolated Trigger Probe (For Fluke 434 to test energy meters)	
AC Current Clamp 200 A (10 mV/A) and 20 A (100 mV/A) switchable.	i200s
AC Current Clamp 2000 A (1 mV/A) and 200 A (10 mV/A) switchable, flexible.	i2000flex
AC Current Clamp 500 A (1 mV/A).	80i-500s
AC Current Clamp 1000 A (1 mV/A), 100 A (10 mV/A), and 10 A (100 mV/A) switchable.	i1000s
AC Current Clamp 3000 A (0.1 mV/A), 300 A (1 mV/A), and 30 A (10 mV/A) switchable.	i3000s
AC/DC Current Clamp 100 A (10 mV/A) and 10 A (100 mV/A) switchable.	80i-110s
AC/DC Current Clamp 400 A (1 mV/A)	i410 and PM9082
AC/DC Current Clamp 600 A AC and 1000 A DC (1 mV/A)	i1010 and PM9082
Service Manual (English)	4822 872 05392

## **Troubleshooting**

**Analyzer does not start up.**

The battery may be completely empty. In this case the Analyzer will not start up, even if it is powered by the Battery Charger/Power Adapter. Charge the battery first: power the Analyzer with the Battery Charger without turning it on. Wait about 15 minutes and try turning on the Analyzer again.

**Analyzer shuts down after a few seconds.**

The battery may be empty. Check the battery symbol in the screen header. The  symbol indicates that the battery is empty and must be charged.

**Screen remains black.**

Make shure that the Analyzer is on: at power-on you should hear a double beep. If the screen remains black, you might have a problem with the screen contrast. Proceed as follows to change Contrast:

- Press the SETUP key.
- Press Function key F4.
- Press the left or right arrow key for five seconds to return to normal display.

**Operation time of fully charged battery is too short.**

The Battery may be in poor condition. This may improve after a full discharge and full charge cycle as explained in section 'Keeping the battery in good condition' in this Chapter.

**Printer does not print.**

- Make shure that the optical interface cable is properly connected between Analyzer and printer.
- Make sure that you have selected the correct printer type and printer baudrate. How to proceed is explained in Chapter 19.
- If you are using the PAC91 (Print Adapter Cable), make sure that it is turned on and that a fresh battery is installed.

**FlukeView does not recognize the Analyzer.**

- Make sure that the Analyzer is turned on.
- Make shure that the optical interface cable is properly connected between Analyzer and PC.

**Other PC software does not recognize the Analyzer.**

- Make sure that the Analyzer is turned on.
- Make shure that the optical interface cable is properly connected between Analyzer and PC.
- Make sure that the correct COM port has been selected for the PC. If not, change the COM port setting or connect the interface cable to another COM port.
- Make sure that baudrate of Analyzer and PC are the same. How to proceed is explained in Chapter 19.

# **Chapter 21**

## **Specifications**

### **Introduction**

#### **Performance Characteristics**

Fluke guarantees the properties expressed in numerical values within the tolerances stated. Numerical values without tolerances are typical and represent the characteristics of an average instrument excluding accessories. The Analyzer meets the specified accuracy 30 minutes and two complete acquisitions after power-on. All operational specifications are valid under the restrictions mentioned in section 'Environmental' unless otherwise specified.

Specifications are based on a one year calibration cycle.

#### **Environmental Data**

The environmental data mentioned in this manual are based on the results of the manufacturer's verification procedures.

#### **Safety Characteristics**

The Analyzer has been designed and tested in accordance with standard EN61010-1 2<sup>nd</sup> edition (2001), Safety Requirements for Electrical Equipment for Measurements Control and Laboratory Use for Class III Pollution Degree 2 instruments.

This manual contains information and warnings that must be followed by the user to ensure safe operation and to keep the Analyzer and its accessories in a safe condition. Use of this Analyzer and its accessories in a manner not specified by the manufacturer may impair the protection provided by the equipment.

## Electrical Measurements

The following specifications of the instrument are verified using the “implementation verification” table 3 as specified in 61000-4-30 chap-6-2.



### FREQUENCY MEASUREMENT

Selected Nominal Frequency (Fnom)	Measurement Range	Resolution	Accuracy
50 Hz	42.50 ... 57.50 Hz	0.01 Hz	± 0.1 % of Fnom
60 Hz	51.00 ... 69.00 Hz	0.01 Hz	± 0.1 % of Fnom

Note: measured on Reference Voltage Input A/L1.

### VOLTAGE MEASUREMENTS

#### Voltage Inputs

Item	Specification	Additional Information
Nominal voltage input range of Vnom (Nominal voltage)	60 V-500 V	Internal divided in three ranges 500 V, 250 V, 125 V
Voltage Scaling factor (Vscale) (display only)	1:1, 10:1, 100:1, 1000:1 variable: xxxx : yyy	All displayed Voltage results are multiplied by the selected Vscale factor.
Numbers of inputs	4	L1/L2/L3 and N(neutral) banana inputs
Input impedance	4 Mohm // 5 pF	
Max range	0 %-200 %	% of selected Vnom
 Max continuous input voltage	1000 Vrms	This is an overload in all ranges except 500V
 Max Vpeak input voltage within dynamic range	≥ ±2,8x selected Vnom	
 Absolute max Vpeak input voltage	6 kV	Max 1,2/50us ;these voltage input pulse is out of dynamic range
Bandwidth	>10 kHz	
Crosstalk between Voltage channels (L1/L2/L3/N)	-60 dB	@ 42,5-67Hz
Crosstalk between Voltage and Current channels	-95 dB	(measured channel grounded)

Note: all following Voltage specifications are based on a Voltage Scaling Factor of 1:1, unless otherwise indicated.



**RMS Voltage**

Selected Nominal Voltage (Vnom)	Measurement Range (CF ≤ 1.4 at full scale)	Resolution	Accuracy
60 ... 125 Vrms	1.0 ... 250.0 Vrms	0.1 Vrms	± 0.5 % of Vnom
125 ... 250 Vrms	1.0 ... 500.0 Vrms	0.1 Vrms	± 0.5 % of Vnom
250 ... 500 Vrms	1.0 ... 999.9 Vrms	0.1 Vrms	± 0.5 % of Vnom

**Peak Voltage**

Selected Nominal Voltage (Vnom)	Measurement Range (CF ≤ 1.4 at full scale)	Resolution	Accuracy
60 ... 125 Vrms	0 ... 350 V	1 V	± 5 % of Vnom
125 ... 250 Vrms	0 ... 700 V	1 V	± 5 % of Vnom
250 ... 500 Vrms	0 ... 1400 V	1 V	± 5 % of Vnom

**Voltage Crest Factor**

Condition	Measurement Range	Resolution	Accuracy
Umeas ≈ Vnom	1.0 ... 2.8	0.1	± 5 %

**Harmonic and Interharmonic Voltages**

Settings	Range	Additional Information
Harmonic selection (n):	DC, 1 ... 50	Grouping: Harmonic Groups according to IEC61000-4-7
Interharmonic selection:	OFF, 1 ... 49	Grouping: Harmonic and Interharmonic Subgroups according to IEC61000-4-7
Amplitude Reference	total RMS / fund. RMS	Used for Relative Amplitude
THD	% total / % fundamental	based on H1 ... H40

Measurement	Measurement Range	Resolution	Accuracy
Relative Amplitude	0.0 ... 100.0 %	0.1 %	$\pm 0.1 \% \pm n \times 0.1 \%$ , ( $\pm 0.4\%$ for %r)
Absolute Amplitude			
Vnom: 60 ... 125 Vrms	0.0 ... 250.0 Vrms	0.1 Vrms	$\pm 5 \%$ of meas $\pm 2$ counts
Vnom: 125 ... 250 Vrms	0.0 ... 500.0 Vrms		
Vnom: 250 ... 500 Vrms	0.0 ... 999.9 Vrms		
Phase	-360° ... +360°	1°	$\pm n \times 1.5^\circ$
Frequency	0 ... 3500 Hz	1 Hz	$\pm 1$ Hz
THD	0.0 ... 100.0 %	0.1 %	$\pm 2.5 \%$
DC relative	0.0 ... 100.0 %	0.1 %	$\pm 1 \%$
absolute	0.0 ... 100.0 V	0.1 V	$\pm 5 \%$ of meas $\pm 10$ counts

### Voltage Dips

Settings	Adjustment Range	Resolution	Additional Information
Dip Threshold level	50.0 ... 100.0 % of Vnom	0.1 %	results based on $\frac{1}{2}$ cycle rms
Dip Hysteresis level	0.0 ... 10.0 % of Vnom	0.1 %	

Measurements	Measurement Range	Resolution	Accuracy
Dip Magnitude	0.0 % ... 100.0 % of Vnom	0.1 %	$\pm 1 \%$ of Vnom
Dip Duration	hhh,mm,ss,mmm	10 ms	$\pm 20$ ms (at F=50 Hz)

### Voltage Swells

Settings	Adjustment Range	Resolution	Additional Information
Swell Threshold level	100.0 ... 200.0 % of Vnom	0.1 %	results based on $\frac{1}{2}$ cycle rms
Swell Hysteresis level	0.0 ... 10.0 % of Vnom	0.1 %	

Measurements	Measurement Range	Resolution	Accuracy
Swell Magnitude	100.0 %...200.0 % of Vnom	0.1%	$\pm 1 \%$ of Vnom
Swell Duration	hhh,mm,ss,mmm	10 ms	$\pm 20$ ms (at F= 50 Hz)

### Voltage Interrupts

Settings	Adjustment Range	Resolution	Additional Information
Interrupt Threshold level	0.0 ... 50.0 % of Vnom	0.1 %	results based on ½ cycle rms
Interrupt Hysteresis level	0.0 ... 10.0 % of Vnom	0.1 %	

Measurements	Measurement Range	Resolution	Accuracy
Interrupt Magnitude	0.0 % ... 100.0 % of Vnom	0.1 %	± 1 % of Vnom
Interrupt Duration	hhh:mm:ss:mmm	10 ms	± 20 ms (at F= 50 Hz)

### Voltage Unbalance

Measurements	Measurement Range	Resolution	Accuracy
Negative Unbalance Ratio	0.0 ... 5.0 %	0.1 %	± 0.5 %
Zero Unbalance Ratio	0.0 ... 5.0 %	0.1 %	± 0.5 %

### Rapid Voltage Changes

Settings	Adjustment Range	Resolution	Additional Information
Steady Voltage Tolerance	0.0 ... 10.0 % of Vnom	0.1 %	results based on ½ cycle rms
Minimum Steady Time	0.0 ... 10.0 s	0.1 s	
Minimum Voltage Difference	0.0 ... 10.0 % of Vnom	0.1 %	
Minimum Rate of Change	0.0 ... 10.0 %/s of Vnom	0.1 %/s	

Measurements	Measurement Range	Resolution	Accuracy
Steady Voltage Difference	0.0 ... 100.0 % of Vnom	0.1 %	± 1 % of Vnom

### Transient Voltages

Settings	Range	Additional Information
Transient Capture Threshold	0 ... 999 % of Vnom	Percentual deviation from the repetitive waveform

Measurements	Measurement Range	Resolution	Accuracy
RMS voltage in Transient Function	10 ... 1000 Vrms	1 Vrms	± 2.5 % of Vnom
Transient voltage (TTRANS > 10 µs)	0 ... ± 6000 Vpeak	1 V	± 15 % of meas

### Flicker

Settings	Adjustment Range	Resolution	Additional Information
Steady Voltage Tolerance	0.0 ... 10.0 % of Vnom	0.1 %	
Minimum Steady Time	0.0 ... 10.0 s	0.1 s	
Maximum Deviation Threshold	0.0 ... 10.0 % of Vnom	0.1 %	

Measurement	Measurement Range	Resolution	Accuracy
PF5	0.00 ... 20.00	0.01	Within ±5 % of tabulated values according IEC61000-4-15
P1min	0.00 ... 20.00	0.01	
Pst	0.00 ... 20.00	0.01	
Plt	0.00 ... 20.00	0.01	
Dc	0.0 ... ± 100.0 %	0.1 %	± 1 % (if Umeas ≈ Vnom)
DMAX	0.0 ... ± 100.0 %	0.1 %	± 1 % (if Umeas ≈ Vnom)
TDEX	0.000 ... 9.999 s	10 ms	20 ms (at F = 50 Hz)

## CURRENT MEASUREMENTS

### Current Inputs

Item	Specification	Additional Information
 Nominal input Range	0 - ±5.625 Vpeak	0 - 3.97 Vrms sinewave
Current Clamp Sensitivity	0.1 , 1, 10, 100, 1000 mV/A variable:	
Input impedance	50 k.ohm	
Bandwidth	>10 kHz	
Voltage resolution	1 mV	

### RMS Current

Selected Clamp Sensitivity	Measurement Range ( CF ≤ 2.8 at full scale)	Resolution	Accuracy (excl. Clamp error)
0.1 mV/A	0.00 ... 20.00 kArms	10 Arms	± 1 % of meas ± 5 counts
1 mV/A	0 ... 2000 Arms	1 Arms	
10 mV/A	0.0 ... 200.0 Arms	0.1 Arms	
100 mV/A	0.00 ... 20.00 Arms	0.01 Arms	
1 V/A	0.000 ... 2.000 Arms	0.001 Arms	

### Harmonic Currents

Settings	Range	Additional Information
Harmonic selection (n):	DC, 1 ... 50	Grouping: Harmonic Groups according to IEC61000-4-7
Interharmonic selection:	OFF, 1 ... 49	Grouping: Harmonic and Interharmonic Subgroups according to IEC61000-4-7
Amplitude Reference	total RMS / fund. RMS	Used for Relative Amplitude
THD	% total / % fundamental	based on H1 ... H40

Measurement	Measurement Range	Resolution	Accuracy ( excl. Clamp error )
Relative Amplitude	0.0 ... 100.0 %	0.1 %	± 0.1 % ± n x 0.1 %
Absolute Amplitude			± 5 % of meas ± 5 counts
0.1 mV/A	0.00 ... 20.00 kArms	10 Arms	
1 mV/A	0 ... 2000 Arms	1 Arms	
10 mV/A	0.0 ... 200.0 Arms	0.1 Arms	
100 mV/A	0.00 ... 20.00 Arms	0.01 Arms	
1 V/A	0.000 ... 2.000 Arms	0.001 Arms	
Phase	-360° ... +360°	1°	± n × 1.5°
Frequency	0 ... 3500 Hz	1 Hz	± 1 Hz
THD	0.0 ... 100.0 %	0.1 %	± 2.5 %
DC relative	0.0 ... 100.0 %	0.1 %	± 1 %
absolute	0.0 ... 100.0 V	0.1 V	± 5 % of meas ± 10 counts

**Inrush Current**

Settings	Adjustment Range	Resolution	Additional Information
Inrush Threshold level	0 ... 999 % of Inom	1 %	Results based on Irms <sub>1/2</sub> ( Itrh - Ihys > Inom )
Inrush Hysteresis level	0 ... 999 % of Inom	1 %	
Inrush Evaluation time	7.5 s, 15 s, 30 s, 1.5 m, 3 m, 6 m, 12 m, 30 m	fixed ranges	

Measurements	Measurement Range	Resolution	Accuracy ( excl. Clamp error )
Inrush Magnitude			
0.1 mV/A	0.00 ... 20.00 kArms	10 Arms	± 1 % of meas ± 5 counts
1 mV/A	0 ... 2000 Arms	1 Arms	
10 mV/A	0.0 ... 200.0 Arms	0.1 Arms	
100 mV/A	0.00 ... 20.00 Arms	0.01 Arms	
1 V/A	0.000 ... 2.000 Arms	0.001 Arms	
Inrush Duration	mm:ss:mmm	10 ms	± 20 ms (at F = 50 Hz)
Current Magnitude			
0.1 mV/A	0.00 ... 20.00 kArms	10 Arms	± 1 % of meas ± 5 counts
1 mV/A	0 ... 2000 Arms	1 Arms	
10 mV/A	0.0 ... 200.0 Arms	0.1 Arms	
100 mV/A	0.00 ... 20.00 Arms	0.01 Arms	
1 V/A	0.000 ... 2.000 Arms	0.001 Arms	

**Current Unbalance**

Measurements	Measurement Range	Resolution	Accuracy ( excl. Clamp error )
Negative Unbalance Ratio	0.0 ... 20.0%	0.1%	± 1%
Zero Unbalance Ratio	0.0 ... 20.0%	0.1%	± 1%

**POWER MEASUREMENT**

**RMS Power (Total or Fundamental)**

W, VA, VAR Ranges:

	<b>V*1</b>	<b>V*10</b>	<b>V*100</b>	<b>V*1000</b>
0.1 mV/A	0.010 MW ... 9.999 MW 10.00 MW ... 20.00 MW	00.10 MW ... 99.99 MW 100.0 MW ... 200.0 MW	001.0 MW ... 999.9 MW 1000 MW ... 2000 MW	0.010 GW ... 9.999 GW 10.00 GW ... 20.00 GW
1 mV/A	001.0 kW ... 999.9 kW 1000 kW ... 2000 kW	0.010 MW ... 9.999 MW 10.00 MW ... 20.00 MW	00.10 MW ... 99.99 MW 100.0 MW ... 200.0 MW	001.0 MW ... 999.9 MW 1000 MW ... 2000 MW
10 mV/A	00.10 kW ... 99.99 kW 100.0 kW ... 200.0 kW	001.0 kW ... 999.9 kW 1000 kW ... 2000 kW	0.010 MW ... 9.999 MW 10.00 MW ... 20.00 MW	00.10 MW ... 99.99 MW 100.0 MW ... 200.0 MW
100 mV/A	0.010 kW ... 9.999 kW 10.00 kW ... 20.00 kW	00.10 kW ... 99.99 kW 100.0 kW ... 200.0 kW	001.0 kW ... 999.9 kW 1000 kW ... 2000 kW	0.010 MW ... 9.999 MW 10.00 MW ... 20.00 MW
1 V/A	001.0 W ... 999.9 W 1000 W ... 2000 W	0.010 kW ... 9.999 kW 10.00 kW ... 20.00 kW	00.10 kW ... 99.99 kW 100.0 kW ... 200.0 kW	001.0 kW ... 999.9 kW 1000 kW ... 2000 kW

W, VA, VAR Resolution and Accuracy:

	<b>Maximum Resolution (lowest range)</b>				<b>Accuracy (excl. Clamp error)</b>
	<b>V*1</b>	<b>V*10</b>	<b>V*100</b>	<b>V*1000</b>	
<b>0.1 mV/A</b>	1 kW	10 kW	100 kW	1 MW	± 1.5 % of meas ± 10 counts
<b>1 mV/A</b>	100 W	1 kW	10 kW	100 kW	
<b>10 mV/A</b>	10 W	100 W	1 kW	10 kW	
<b>100 mV/A</b>	1 W	10 W	100 W	1 kW	
<b>1 V/A</b>	0.1 W	1 W	10 W	100 W	

PF, DPF, COS $\Phi$ :

Measurement	Measurement Range	Resolution	Accuracy (excl. Clamp error)
Power Factor	0.00 ... 1.00	0.01	$\pm 0.03$
Displacement Power Factor	0.00 ... 1.00	0.01	$\pm 0.03$
COS $\Phi$	0.00 ... 1.00	0.01	$\pm 0.03$

Harmonic Power (Watts only)

Settings	Range	Additional Information
Harmonic selection (n):	DC, 1 ... 50	Grouping: Harmonic Groups
Amplitude Reference	total Power / fund. Power	Used for Relative Amplitude
THD	% total / % fundamental	based on H1 ... H40

Measurement:	Measurement Range	Resolution	Accuracy (excl. Clamp error)
Relative Amplitude	0.0 ... 100.0 %	0.1 %	$\pm n \times 2 \%$
Absolute Amplitude 0.1 mV/A ... 1 V/A V*1 ... V*1000	as indicated under W, VA, VAR ranges	as indicated under W, VA, VAR resolution and accuracy	$\pm 5 \%$ $\pm n \times 2 \%$ of meas $\pm 10$ counts
Phase between In - Vn	-360° ... +360°	1°	$\pm n \times 1.5^\circ$
Frequency	0 ... 3500 Hz	1 Hz	$\pm 1$ Hz
THD	0.0 ... 100.0 %	0.1%	$\pm 5 \%$
DC relative	0.0 ... 100.0 %	0.1 %	$\pm 2 \%$
absolute	0.0 ... 100.0 V	0.1 V	$\pm 5 \%$ of meas $\pm 10$ counts



### Energy

Whr, VAhr, VARhr Ranges:

	V*1	V*10	V*100	V*1000
<b>0.1 mV/A</b>	000.0 kWhr ... 200.0 GWhr	0.000 MWhr ... 2.000 TWhr	00.00 MWhr ... 20.00 TWhr	000.0 MWhr ... 200.0 TWhr
<b>1 mV/A</b>	00.00 kWhr ... 20.00 GWhr	000.0 kWhr ... 200.0 GWhr	0.000 MWhr ... 2.000 TWhr	00.00 MWhr ... 20.00 TWhr
<b>10 mV/A</b>	0.000 kWhr ... 2.000 GWhr	00.00 kWhr ... 20.00 GWhr	000.0 kWhr ... 200.0 GWhr	0.000 MWhr ... 2.000 TWhr
<b>100 mV/A</b>	000.0 Whr ... 200.0 MWhr	0.000 kWhr ... 2.000 GWhr	00.00 kWhr ... 20.00 GWhr	000.0 kWhr ... 200.0 GWhr
<b>1 V/A</b>	00.00 Whr ... 200.0 kWhr	000.0 Whr ... 200.0 MWhr	0.000 kWhr ... 2.000 GWhr	00.00 kWhr ... 20.00 GWhr
Maximum Integration Time: 9999 hours				

Whr, VAhr, Resolution and Accuracy:

	Maximum Resolution (lowest range)				Accuracy (excl. Clamp error)
	V*1	V*10	V*100	V*1000	
<b>0.1 mV/A</b>	100 Whr	1 kWhr	10 kWhr	100 kWhr	± 1.5% of meas ± 10 counts
<b>1 mV/A</b>	10 Whr	100 Whr	1 kWhr	10 kWhr	
<b>10 mV/A</b>	1 Whr	10 Whr	100 Whr	1 kWhr	
<b>100 mV/A</b>	0.1 Whr	1 Whr	10 Whr	100 Whr	
<b>1 V/A</b>	0.01 Whr	0.1 Whr	1 Whr	10 Whr	

Note: The Usage scale (in Whrs) starts a factor 10 lower than the equivalent Power scale (in W). This means that after 6 minutes the Usage number and the Power number are of the same magnitude.

## Trend Recording

### General

Item	Specification
Resolution	1s, 5s, 30s, 1m, 5m, 15m, 30m, 1h, 3h, 6h
Duration	0.5h, 2.5h, 7.5h, 15h, 30h, 150h, 450h, 900h, 75d, 225d, 450d
Memory	1800 min, max, and avg. points for each reading

### Dips and Swells

Item	Specification
Resolution	25ms, 50ms, 100ms, 200ms, 500ms, 1s, ... , 450d
Duration	90s, 180s, 6m, 12m, 30m
Memory	3600 min, max, and avg. points for each reading

### Inrush mode

Item	Specification
Resolution	25ms, 50ms, 100ms, 200ms, 500ms
Duration	90s, 180s, 6m, 12m, 30m
Memory	3600 min, max, and avg. points for each reading

### Wiring Combinations

Abbreviation on Configuration Screen	Description
1Ø + NEUTRAL	Single Phase with Neutral
1Ø IT NO NEUTRAL	Single Phase IT without Neutral
2Ø Split Phase	Split Phase with Neutral
3Ø WYE	3-Phase Wye with Neutral
3Ø IT	3-Phase Wye IT without Neutral
3Ø DELTA	3-Phase Delta
3Ø HIGH LEG	3-Phase Delta High Leg
3Ø OPEN LEG	3-Phase Delta Open Leg

## Display

Item	Specification	Additional Information
Type	LCD color ¼ VGA	Liquid Crystal Display color version
Viewing area	118.2 x 89.4 mm	
Resolution	320 x 240 pixels	
Contrast adjustment	between full white and full black	Adjustable/optimum contrast @ every operating temperature
Backlight: Type	CCFL	All values are typical values
light output (battery operated)	50 cd/m <sup>2</sup> @ 25 °C 80 cd/m <sup>2</sup> @ 25 °C 20 cd/m <sup>2</sup> @ 25 °C	After warm-up time of 10 min. When backlight button pressed Low intensity mode
light output (with power adapter)	80 cd/m <sup>2</sup> @ 25 °C 20 cd/m <sup>2</sup> @ 25 °C	After warm-up time of 10 min. Low intensity mode

## Memory

Item	Specification	Additional Information
Memory locations for screens	Fluke 434: 50. Fluke 433: 25.	Extended memory optionally available for Fluke 433
Memory locations for datasets	Fluke 434: 10. Fluke 433: 5.	

## Printers and Interface

Item	Specification	Additional Information
Type	RS-232, optically isolated	To be used with interface cable to RS-232 with 9-pole D-plug male ( PM9080) or USB (OC4USB)
Spacing "0" "1"	Light No light	
Baud rate	1200, 2400, 9600 ... 57k6	
Stop bits	1	
Data bits	8	
Parity	No	
Transmission mode	Asynchronous, full duplex	
Handshake	Xon Xoff	Software handshake only.
Print out facility	Via optical RS-232 Via serial/parallel converter	PM9080 or PAC 91
Protocol	Epson FX LQ compatible, Deskjet, LaserJet , DPU-414, PostScript	Pure B&W.

## Power Supply and Battery Charger

Item	Specification	Additional Information
Operating Time	7 hours	With Backlight at low intensity
Charge Time	4 hours, 8 hours for /006 version	If instrument is Off
Allowed ambient temperature during charge	0 °C ... 40 °C	
Remaining Battery Time indicator	Yes, in five steps, NOT guaranteed	The instrument will show a remaining battery capacity. This indication has no absolute accuracy; it is only used as an indication.
 Power adapter input Voltage	15 ... 23 V dc	Use only power adapter BC430.
NiMH Battery Pack	BP190	

## ***Mechanical***

<b>Item</b>	<b>Customer Specification</b>	<b>Additional Information</b>
Height x Width x Depth	256 x 169 x 64 mm	10.1 x 6.6 x 2.5 inch
Weight	2.1 kg (4.7 lbs)	Including battery pack excluding current clamps or test leads

## ***Environmental***

<b>Item</b>	<b>Customer Specification</b>	<b>Additional Information</b>
Temperature Operating within specifications Operating with reduced specifications Non Operating (Storage)	+15 °C ... +35 °C 0 °C ... +50 °C 0 °C ... +40 °C -20°C ... +60 °C	battery operation only with power adapter connected
Maximum Relative Humidity Non Operating (Storage): Operating: 0 ... 10 °C 10 ... 30 °C 30 ... 40 °C 40 ... 50 °C	No precipitation (non cond.) No precipitation (non cond.) 95 % ± 5 % 75 % ± 5 % 45 % ± 5 %	Recovery time two hours  No precipitation (no condensing)  battery operation only
Maximum Altitude Operating  Non Operating	3000 m (10 000 feet)  12 km (40 000 feet)	Above 2000 m derated overvoltage category 1000V/CATII, 600V/CATIII, 300V/CATIV
Vibration: Random  Sinusoidal	0.03 g <sup>2</sup> /Hz  3 g	Operating, maximum limits. MIL-PRF-28800F, class 2, 3.8.4.1&4.5.5.3.1 MIL-PRF-28800F, class 2, 3.8.4.2&4.5.5.3.2
Shock, functional	max 30 g	MIL-PRF-28800F, class 2, 3.8.5.1&4.5.5.4.1
Bench handling (operating)	yes	MIL-PRF-28800F, class 2, 3.8.5.3&4.5.5.4.3
Transit drop	1 meter, see Fluke SOP 39.1, dated Sept. 22, 1992	
Drip proof, Dust resistance	IP 51	IEC60529 (2001-02)



## Electro Magnetic Compatibility (EMC)

Item	Customer Specification	Additional Information
Emission and Immunity	EN-61326	Fluke 433/434, including standard accessories, conforms with the EEC directive 89/336 for EMC immunity, as defined by EN-61326, with the addition of the table below

Frequency	Disturbance < 0.5 %	Disturbance < 10 %
80 – 400 MHz	All ranges	
400 – 600 MHz	All other ranges	125 V range
600 MHz – 1 GHz	All ranges	

The Analyzer is susceptible for RF fields with a field strength of 10 V/m, between 400 and 600 MHz (Performance criteria B).

## Safety

Item	Customer Specification	Additional Information
 including approval Reference Standards	EN/IEC61010-1 2nd edition 1000V Measurement Category III, 600V Measurement Category IV, Pollution Degree 2. ANSI/ISA S82.01-1994 CAN/CSA C22.2 No. 61010-1-04 (including approval)	According to CE marking
 Max voltage between any Voltage banana input and safety ground	1000 V CAT III 600 V CAT IV	At altitude 2000 m ... 3000 m: 1000 V CAT II, 600 V CAT III, 300 V CAT IV
 42 V <sub>peak</sub> Max voltage on Current BNC input		REMARK: the BNC grounds of the BNC's are connected to the ground banana input

# Index

## —A—

A range, 18-4  
Accessories, 1-1  
Active power, 11-2  
Apparent power, 11-2

## —B—

Banana Inputs, 6-1  
Bar Graph screen, 5-2  
Battery Charger, 1-6  
Battery Condition, 20-1  
Battery save, 18-12  
BNC Inputs, 6-1  
Brightness, 4-3

## —C—

Calibration, 21-1  
Capacitive load, 11-2  
CF, 8-1  
Change Offset and Span, 18-9  
Change wiring config, 18-5  
Characteristics, 21-1  
Charge Batteries, 4-2  
CHG, 9-5, 16-5  
Clamp, 18-4  
Cleaning, 20-1  
Clock, 5-3  
Colors, 5-2, 18-12  
Configuration, 5-3  
Configuration, wiring, 18-3  
Conformity, 1-1  
Contrast, 4-4  
Contrast adjustment, 18-12  
Cos  $\phi$ , 11-2  
Count down, 5-3  
Crest Factor, 8-1  
Current clamps, 6-2

Cursor, 17-1

## —D—

Datasets, 19-1  
Date, 5-3, 18-3  
DC, 10-1  
Decals, 6-1  
Default settings, 18-8  
Defaults, 4-4  
Demand interval, 11-3  
Demo Mode, 18-8  
DIP, 9-5, 16-5  
Dips, 9-1  
Displacement power factor, 11-2  
Display, 4-3  
DPF, 11-2  
Duration, 9-1

## —F—

F1 ... F5, 5-3  
Factory defaults, 18-12  
Features, 3-1  
Flagged, 5-3  
Flicker, 12-1  
Fluke 433, 20-1  
**Fluke 434**, 3-1, 11-1, 14-1, 15-1, 19-1  
Freq, 18-4  
Frequency nominal, 5-3  
Full, 11-1  
Function Preferences, 18-7  
Fundamental, 11-1

## —G—

Getting Started, 2-1

## —H—

Hang Strap, 4-1

Harmonics, 10-1  
Hx, 16-5  
Hysteresis, 9-1, 15-2

### —I—

Inductive load, 11-2  
Inputs, 6-1  
Inrush currents, 15-1  
Inrush time, 15-2  
INT, 9-5, 16-5  
Interharmonics, 10-1  
Interruptions, 9-1

### —K—

Keyboard Lock, 4-3  
K-factor, 10-1  
kVA, 11-2  
kVAR, 11-2  
kW, 11-2

### —L—

Language, 18-4  
Limits, 5-3, 16-2  
Limits Setup, 18-13  
Lock, 4-3  
Locked keyboard, 5-3  
Long term severity, 12-2  
Luminance fluctuation, 12-1

### —M—

Magnitude, 9-1  
Manual, 2-1  
Measuring mode, 5-2  
Measuring modes, 3-2  
Measuring values, 5-2  
Memory, 19-1  
Menu Navigation, 4-4  
Momentary flicker, 12-2  
Monitor, 3-1, 16-1

### —N—

Negative sequence, 10-4, 13-4  
Numerical values, 8-1

### —O—

Offset, 18-7  
Optional parts, 20-3  
Options, 20-1  
Oscilloscope, 7-1

### —P—

Parts, 20-2  
PC, 19-3  
PF, 11-2

Phase Colors, 5-2  
Phase Identification, 18-11  
Phasor screen, 5-2, 7-2  
Positive sequence, 10-4, 13-4  
Power, 4-2  
Power Adapter, 1-6  
Power and Energy, 11-1  
Power factor, 11-2  
Power Quality Monitor, 16-1  
Present values, 18-1  
Printer, 19-3  
Printer Setup, 18-12  
Probability, 16-3  
Pulse count mode, 11-2

### —R—

Rapid Voltage Changes, 9-1  
Reactive power, 11-2  
Real power, 11-2  
Recording, 5-3  
Reference phase, 6-2  
Reset, 4-4  
RS-232 Setup, 18-12

### —S—

Safety, 1-1  
Screen Types, 5-1  
Screenshots, 19-1  
Service Center, 1-1  
Setting up the Analyzer, 18-1  
Shipment Note, 1-1  
Short term severity, 12-2  
Shrink display, 17-1  
Signal Polarity, 6-2  
Single phase, 6-2  
Sliding reference voltage, 9-1  
Softkeys, 5-3  
Span, 18-7  
Standard parts, 20-2  
Status indicators, 5-3  
Status line, 5-3  
Stickers, 6-1  
Storage, 20-1  
Stretch display, 17-1  
Swells, 9-1  
SWL, 9-5, 16-5  
Symbols, 5-3, 16-5  
System Monitor, 16-1  
System Monitor, 3-1

### —T—

Table screen, 5-2  
Technical data, 21-1  
THD, 10-1  
Threshold, 9-1, 15-2  
Tilt Stand, 4-1



Time, 5-3, 18-3  
Transients, 14-1  
Trend screen, 5-2  
Trigger conditions, 18-7  
Troubleshooting, 20-3

**—U—**

U, Unstable, 5-3  
Unbalance, 13-1  
Usage, 11-1  
User ID, 18-12  
Users Manual, 2-1  
Using Memory, 19-1

**—V—**

Vector diagram, 7-2

Version & Cal, 18-4  
Vnom, 18-3  
Voltage nominal, 5-3  
Voltage range, 1-6  
Volts/Amps/Hertz, 8-1

**—W—**

Warranty, 1-1  
Waveform screen, 5-2  
Wiring configuration, 5-3

**—Z—**

Zero sequence, 10-4, 13-4  
Zoom, 5-3, 17-1

